

ZM4

External hex connection implants

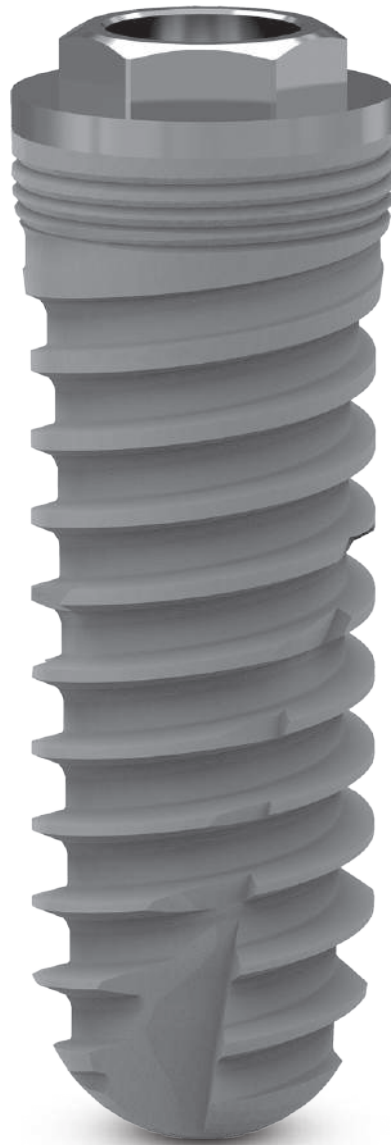

ZM4

External hex connection implants



Important information

Please read carefully before using Ziacom® products

General information

This document contains basic information on the use of original Ziacom® dental implant systems, hereafter referred to as "Ziacom® dental implants" or simply "Ziacom® products". This document has been created as a quick guide for clinicians responsible for treatment, hereafter the "user", and therefore, is neither an alternative nor a substitute for specialised training or professional clinical experience.

Ziacom® products must be used according to a suitable treatment plan and in strict compliance with the manufacturer's surgical and prosthetic protocols. Carefully read the product-specific surgical and prosthetic protocols and the instructions for use and maintenance before using any Ziacom® product. You can find this information on our website, www.ziacom.com, or request it from your nearest authorised Ziacom® distributor.

Liability, safety and warranty

The instructions for the use and handling of Ziacom® products are based on internationally published literature, current clinical standards and our clinical experience so they should be understood as general guidance. The handling and use of Ziacom® products is the sole responsibility of the user as it is outside the control of Ziacom Medical SL. Ziacom Medical SL, its subsidiaries and/or its authorised distributors disclaim all responsibility, whether explicit or implicit, total or partial, for possible damage or injury caused by poor handling of the product or any other situation not considered in their protocols and manuals for the correct use of their products.

The user must ensure that the Ziacom® product is appropriate for the intended procedure and end purpose. Neither these instructions for use nor the work or handling protocols for the products release the user from this obligation. Ziacom® products must be used, handled and applied by clinicians with the appropriate training and qualifications required according to current legislation in each country.

The total or partial use, handling and/or application of Ziacom® products at any stage of their implementation by personnel who are unqualified or lack the necessary training will automatically void any type of warranty and may cause severe damage to the patient's health.

Ziacom® products are part of their own system, with their own design characteristics and work protocols, including dental implants, abutments or prosthetic components and surgical or prosthetic instruments. The use of Ziacom® products in combination with elements or components from other manufacturers could result in treatment failure, damage to tissues or bone structures, inadequate aesthetic outcomes and severe damage to the patient's health. Therefore, only original Ziacom® products should be used.

The clinician in charge of the treatment is solely responsible for ensuring the use of original Ziacom® products and that they are used according to the corresponding instructions for use and handling protocols throughout the implant procedure. The use of any other non-original Ziacom® components, instruments or products, whether alone or in combination with any original Ziacom® products, will immediately void the warranty of the original Ziacom® products.

See the Ziacom Medical SL Warranty Programme (available on the website or by contacting Ziacom Medical SL, its subsidiaries or authorised distributors).

Warning. Not all Ziacom® products are available in all counties. Check availability in your country.

The Ziacom® brand and the names of other products and services, including their logos, that are mentioned in this document or on the website www.ziacom.com are registered trademarks of Ziacom Medical SL.

Ziacom Medical SL reserves the right to modify, change, remove or update any of the products, prices or technical specifications referenced on this website or in any of its documents without prior notification. All rights reserved. The reproduction of this document, whole or in part and in any medium or format, without the corresponding written authorisation from Ziacom Medical SL is prohibited.





Table of contents

The Company	06
Together for health	06
Zicom® quality	06
Zitium® Titanium	06
Investment in innovation and training	07
Zicom® across the globe	07
- Regional headquarters	07
- Subsidiaries	07

ZM4 external hex connection implants

ZM4 implant	10
Features	10
Diameters and lengths	11
Surface treatments	12
- Titansure surface treatment	12
Product presentation	14
ZM4 product details	16
Recommendations for use	17
How to use this catalogue	18
Product sheet	18
Symbology	18
Abutments Direct-to-implant restorations	20
Abutments Transepithelial restorations	30
Surgical instruments	40
Prosthetic instruments	48
Surgical protocol	54
Cleaning, disinfection and sterilisation	76

The Company

Together for health

Ziacom® has been working for more than 20 years to improve the **oral health** and well-being of patients around the world by **designing and manufacturing innovative**, high-quality dental implant, prosthetic component, surgical instrument and biomaterial solutions.

The company was founded in 2004 with **100% Spanish capital** and began its activity as a manufacturer of dental implants and attachments for several European companies before later launching its own **brand of implant systems** in 2006.

In 2015, Ziacom® introduced its **diversification strategy** with the development of **new business lines** and new product lines and the launch of a **new portfolio**, which helped the company achieve a **15% share of the Spanish market** in 2016 with the sale of more than 230.000 implants.

In 2022, the company began an **ambitious growth plan** with new goals of **international expansion**, broadening and **diversification** of its portfolio of **products and services** and a change in corporate identity.

Ziacom® quality

Commitment to **quality and innovation** has been part of the values and the essence of Ziacom® since the beginning.

That is why we use state-of-the-art technology in **every stage of our products' production cycle**, from **design and manufacture to quality assurance, cleaning and packaging**. All of our products are also manufactured using only **high-quality raw materials** after applying **strict controls to select** our main suppliers.

Ziacom Medical S.L. is a **licensed manufacturer of medical devices** and an **AEMPS (Spanish Agency of Medicines and Medical Devices)** 6425-PS marketing authorisation holder. Our **quality management**

system is certified in accordance with the requirements of ISO standards 9001:2015 and 13485:2018, and is also GMP 21 CFR 820 compliant.



Thanks to our ceaseless endeavours to offer our clients unsurpassable quality, all our implants have a **lifetime guarantee**.

See the General Conditions for Accessing the Warranty for Ziacom® products.

Zitium® titanium

Ziacom® ZM4 implants are made from extra-high-strength grade 4 **Zitium® titanium**, which bestows them with **substantially improved elastic limit and mechanical properties**.

With **Zitium®** our implants meet the requirements of standards ASTM F67 and ISO 5832-3, and are certified in accordance with EU Regulation 2017/745, attaining the corresponding CE marking from notified body 0051.

Properties of Zitium® titanium

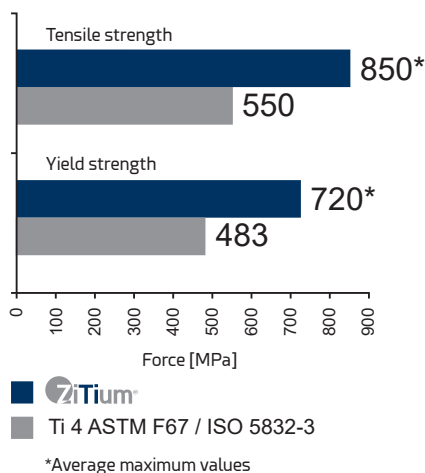

FDA Approved*

*See approved models

Ziacom® dental implants are all sterilised using beta-ray radiation at 25 kGy, apart from the DSQ orthodontic implants, which are supplied **non-sterile**.

IMPORTANT

All the products (except dental implants) listed in this Ziacom® catalogue are supplied non-sterile and must be sterilised before use.



Investment in innovation and training

In order to always offer the very best solutions for the **well-being of every patient**, and thanks to the experience and dedication of our **highly-qualified professionals** and **innovative Technological Centre**, our R&D&I team works incessantly in the field of **research and innovation** to **improve** our products and develop **new solutions** to meet the demands and needs of both patients and dentists.

We also invest in **research** and **ongoing training** as a way of providing **scientific support to the sector** and we firmly believe in training **young professionals** to best ensure **advances in the dentistry field**.

We therefore work closely with **training centres, universities and scientific bodies** to create a practical and specialised teaching

environment to promote and strengthen their knowledge, abilities and professional growth.

In order to enhance our investment in the training and **development of dental professionals**, we have **specific areas at our facilities for hands-on training and practicals**, **state-of-the-art** training equipment and also a **physical and virtual showroom** where professionals can see all our dental solutions first hand.

Ziacom® across the globe

We are committed to making oral health available to patients all over the world and have a solid **internal growth and expansion plan** to increase the company's **international presence** in those **areas where our products are already well-established** and to **expand into new areas**.

In order to achieve this, we offer our **international associates** a **trusting and collaborative** partnership by adapting to their **local needs** and providing solutions that are specific to each market.

As part of our commitment to meet the specific **quality, regulatory and legal requirements of each country**, for both the registration and distribution of our products, we have **specific certifications** from each of the countries in which we trade.

Regional headquarters

Ziacom Medical

Madrid - SPAIN
Calle Búhos, 2 - 28320 Pinto
☎ +34 91 723 33 06

Subsidiaries

Ziacom Lusobionic

Av. Miguel Bombarda, 36 - 5° B
1050 -165 - Lisbon - PORTUGAL
☎ +351 215 850 209

Ziacom Medical USA LLC

Miami - USA
333 S.E 2nd Avenue, Suite 2000
Miami, FL 33131 - USA
☎ +1(786) 224 - 0089

Ziacom ITS

Viale del Lavoro, 14
35010 Vigonza
Padova - ITALY
☎ +39 049 603310

Ziacom Safe implant

Av. Iñaquito, Edificio Metropolitan,
Oficina 304
170507, Quito - ECUADOR
☎ +593 96 368 0879

Please see the up-to-date list of Ziacom® distributors at www.ziacom.com or email us at export@ziacom.com



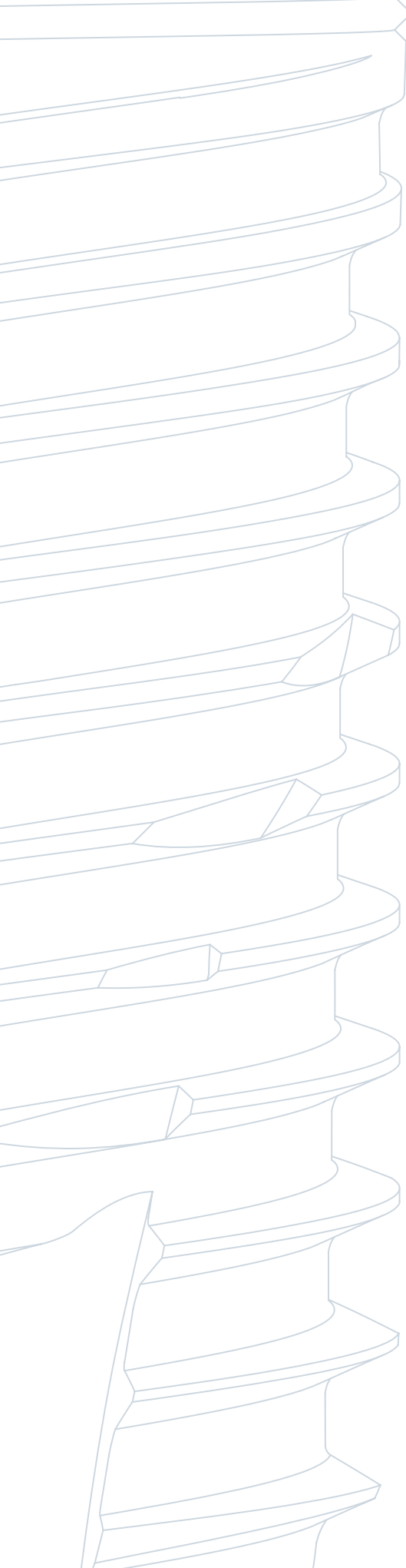

ZM4

ZM4



External hex connection implants

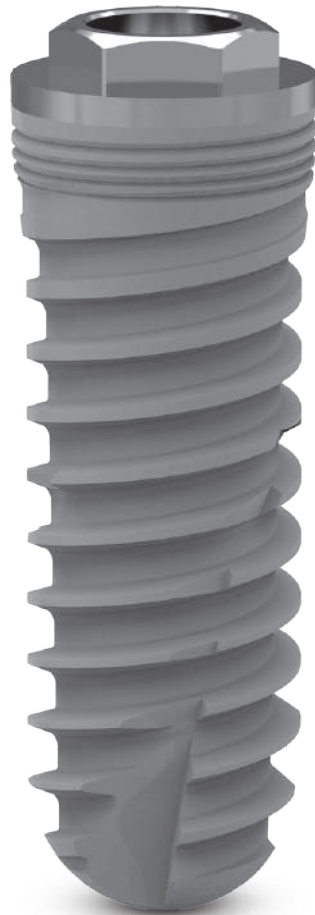

ZM4 implant

Characteristics

CONNECTION

- External hex connection
- Screw channel with upper guide: facilitates screw insertion.

CORTICAL ZONE

- 0.4 mm machined ring: allows the prosthetic gap to be raised with respect to the bone ridge in average/thick biotypes; avoids exposing the treated surface of irregular ridges.
- Microthread design: preserves marginal bone.
- Microthread extension: improves load distribution.
- Macrodesign: optimal cortical compression.

BODY

- Reduced-angle active threads: improve stability during insertion and increase BIC (bone-to-implant contact).
- Double threaded: quick insertion and shorter surgical time.
- Self-tapping active apex: facilitates insertion with underdrilling.
- Transverse apical windows: collect remnants of bone during insertion.
- Optimised morphology: high primary stability.
- Atraumatic apex: no damage to anatomical structures.

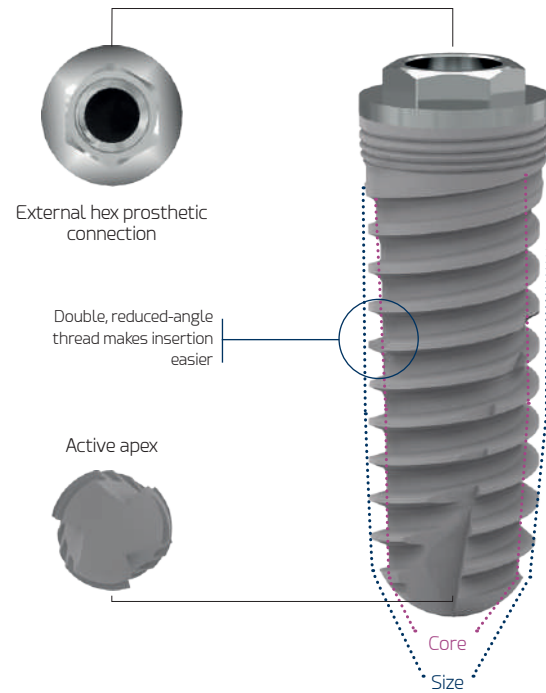



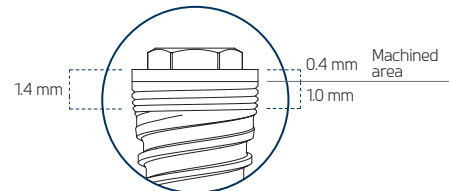







































Dimensions of the implant collar



Advantages

- Simple design: cylindrical implants have a tubular shape along their entire length. This makes them easier to place.
- Initial stability: they offer good retention. They are ideal for patients with sufficient bone density in the placement area.
- Durability: cylindrical implants are reliable and durable. They provide a solid base for the crown or dental prosthesis.

Diameters and lengths

Ø DIAMETER	Ø PLATFORM	LENGTH (L)						
		6	7	8.5	10	11.5	13	14.5
 NP 3.30	3.30							
 RP 3.70	4.10							
 RP 4.00								
 RP 4.30								
 WP 4.60	5.00							
 WP 5.00								

Dimensions in mm.

ZM4 implant

Surface treatments

■ Titansure surface

Implants inserted following surface treatment are known to benefit from improved osseointegration by increasing the bone-to-implant contact area. This is partly due to the implant's chemical composition and topographical characteristics.

With its **Titansure** surface treatment, Ziacom® achieves contaminant-free surface topography and optimal average macro and microporosity values, which are key specifications for achieving prompt and proper osseointegration and, in turn, extremely reliable and predictable implants.

■ ANALYSIS OF THE TITANSURE SURFACE TREATMENT

Titansure is an SLA surface treatment created through a subtraction process involving sandblasting with white aluminium oxide and double acid-etching with hydrofluoric acid and a sulphuric/phosphoric acid mix.

Surface morphology analysis

With the aid of a scanning electron microscope (FEI TENEO, Thermo Fisher Scientific Inc., Waltham, MA, USA), we can see the rough, porous surface creating numerous cavities with thin, sharp edges.

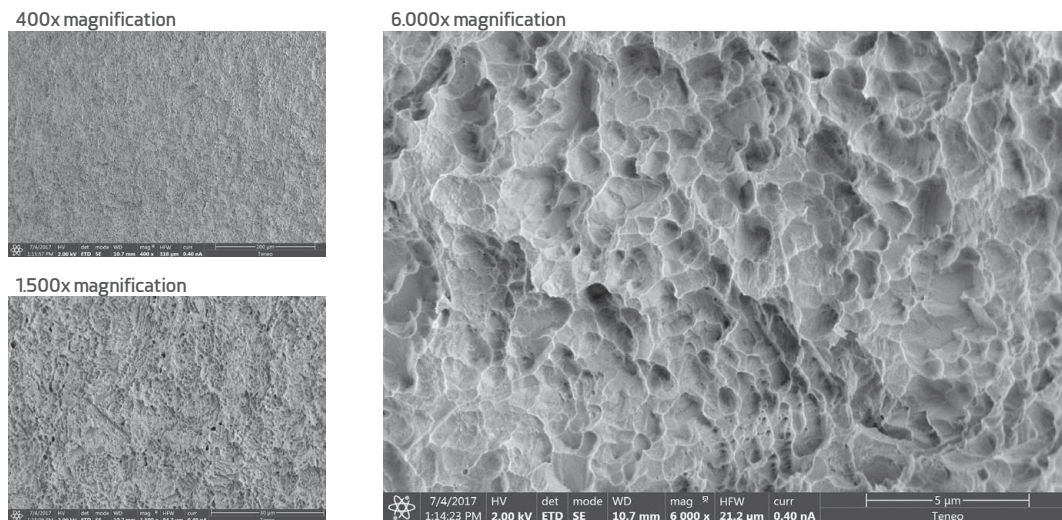

Surface elemental analysis

We used an energy-dispersive X-ray spectrometer (Octane Super, Edax-Ametek, Mahwah, NJ, USA) to analyse the chemical composition at the surface.

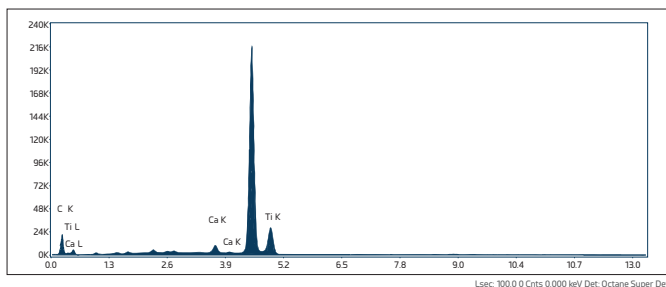

Compositional analysis of implant surface

ELEMENT	WEIGHT (%)
C K	9.32 (10.23)
AL K	-
Ti K	89.53 (11.77)

No aluminium was detected

Results are expressed as the mean and standard deviation of the mass percentage (WEIGHT (%)).

Surface roughness analysis

The roughness study was conducted with a Sensofar S NEOX interferometric-confocal microscope (Sensofar Medical, Terrasa, Spain) and SensoMAP Premium 7.4 software. The quantitative roughness profile parameters applied were: average roughness (Ra), root-mean-square roughness (Rq), maximum profile peak height roughness (Rp) and maximum profile valley depth roughness (Rv).

Ra (µm) (SD)	Rq (µm) (SD)	Rp (µm) (SD)	Rv (µm) (SD)
0.82 (0.10)	0.97 (0.08)	1.84 (0.04)	2.21 (0.01)

The 3D surface roughness (Sa), 3D root mean square height (Sq), maximum 3D peak height (Sp) and maximum 3D pit depth of the selected area (Sv) were also recorded.

Sa (µm) (SD)	Sq (µm) (SD)	Sp (µm) (SD)	Sv (µm) (SD)
0.76 (0.01)	0.97 (0.01)	4.20 (0.12)	4.62 (0.20)

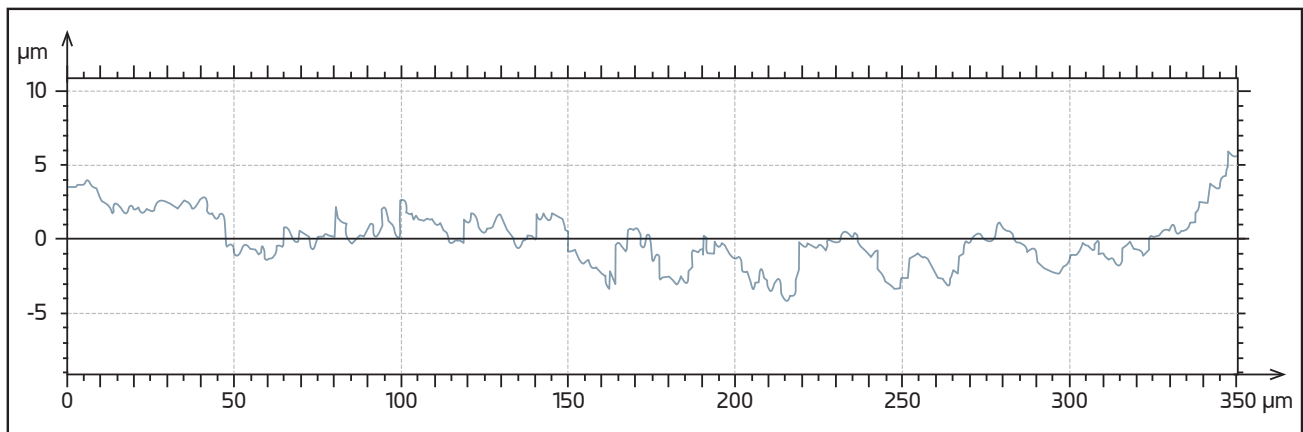

The data were extracted from:

Rizo-Gorrita, M.; Fernandez-Asian, I.; Garcia-de-Frenza, A.; Vazquez-Pachon, C.; Serrera-Figallo, M.; Torres-Lagares, D.; Gutierrez-Perez, J. Influence of Three Dental Implant Surfaces on Cell Viability and Bone Behavior. An In Vitro and a Histometric Study in a Rabbit Model. Appl. Sci. 2020, 10(14), 4790

■ OPTIMAL OSSEOINTEGRATION

The **Titansure** surface has a three-dimensional surface structure with high peaks and broad troughs, which is known to be highly effective at promoting the coagulation cascade and the release of growth factors through platelet activation [Kim, H.; Choi, S.H.; Ryu, J.J.; Koh, S.Y.; Park, J.H.; Lee, I.S. The biocompatibility of SLA-treated titanium implants. Biomed. Mater. 2008. 3. 025011].

This type of surface may have an osteogenic effect thanks to its different topographical features at a micrometer and nanometer level, which has a very similar morphology to the osteoclastic bone resorption cavities [Le Guehennec, L.; Goyenvalle, E.; Lopez-Heredia, M.A.; Weiss, P.; Amouriq, Y.; Layrolle, P. Histomorphometric analysis of the osseointegration of four different implant surfaces in the femoral epiphyses of rabbits. Clin. Oral Implants Res. 2008. 19. 1103-1110].

For more information on the surface treatment, please see the literature available at www.ziacom.es/biblioteca





ZM4 implant

Product presentation

■ Blister packaging

Available for implants with **Titansure** surface. The blisters are heat-sealed and include identification labels for product traceability. There is a flap for easy opening in the surgery while preventing accidental opening.



Titansure

IMPORTANT

Do not open the sterile container until just before inserting the implant.

■ Outer identification label

Ziacom® implants are supplied in a sealed cardboard box that includes a product identification label with a description of their main characteristics.

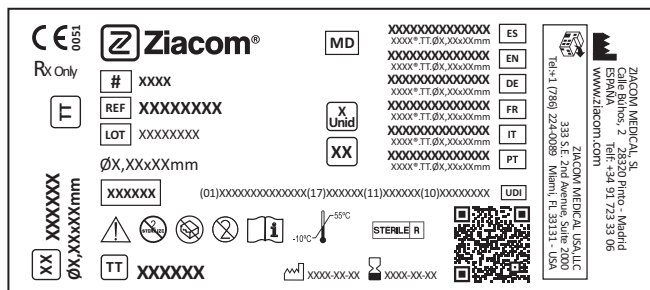

Description of the symbology used

- | | | | |
|-----------|--|---------|-------------------------------------|
| CE XXXX | CE marking (MDR) and notified body number. | | Do not use if package is damaged. |
| MD | Medical device symbol. | | Single-use product. |
| # | Model code. | | Consult instructions for use. |
| REF | Product name. | | Product use-by date. |
| LOT | Product batch number. | | Date of manufacture. |
| UDI | Unique device identifier. | | Manufacturer. |
| STERILE R | Sterilised by radiation. | TT | Titansure surface treatment. |
| | Temperature limit. | TTA | Titansure Active surface treatment. |
| | Caution, consult attached documentation. | Rx Only | Prescription only. |
| | Do not resterilise. | | Product distributor. |

For full details on the product presentation and instructions for use (IFU), go to www.ziacomes/ifu or scan the QR code on the box.



■ ZPlus Mount

The ZM4 implant includes the **ZPlus mount**, a multi-functional abutment made in grade 5 ELI titanium (medical grade), which allows easy handling of the implant during the surgical procedure and incorporates multiple usage functions. Additionally, the concept of the **ZPlus Mount** is based on reducing treatment costs, as it works equally well as an implant mount, impression abutment, or abutment for provisional cement- or screw-retained restorations.

The **ZPlus Mount** is available in the Zinic® SX, Zinic® MTX, ZM4, ZM4 MT and ZM1 ranges.

As indicated, the **ZPlus Mount** can be used as a provisional abutment. In such cases, the **ZPlus** should be sculpted extra-orally and adjusted on an analogue – preferably a lab model or clamp. Check also the structural integrity of the mount and screw, to ensure that they have not suffered any deformation or damage due to excessive insertion torque or forced removal manoeuvre. Additionally, verify on an analogue that the **ZPlus** fixing screw is well fitted and that the connection is secure.

IMPORTANT

Always follow the surgical protocol when placing the implant. This will protect the mount and screw from possible damage which could prevent it being used later as an impression or provisional abutment. Use each **ZPlus** only with the implant to which it belongs. To avoid mix-ups, keep the **ZPlus** and screw with the patient's ID, listing the corresponding reference and batch number. The **ZPlus** has 3 flat sides. After finishing the implant placement procedure, ensure that one of these faces into the vestibular cavity.

Uses of the ZPlus mount

As an implant carrier

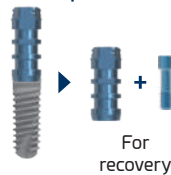

As an impression transfer

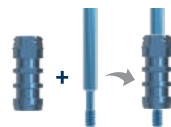

As a provisional abutment for cemented or screwed restorations

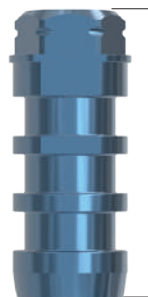
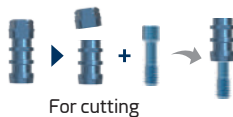

11.00 mm

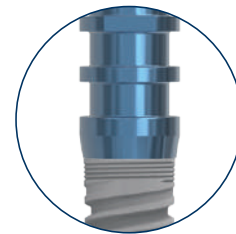

View of implant + Mount

ZM4 implant

ZM4 product details

ZM4 with ZPlus - Titansure product details

IMPLANT				
	Ø Size (mm)	Ø Core (mm)	Length (mm)	Ref. Titansure
ZM4	3.30	2.80/2.50	8.5	ZM43385
			10.0	ZM43310
			11.5	ZM43311
			13.0	ZM43313
			14.5	ZM43314
3.70	3.20/2.80	8.5	ZM43785	
		10.0	ZM43710	
		11.5	ZM43711	
		13.0	ZM43713	
		14.5	ZM43714	
4.00	3.40/3.05	6.0	ZM44006	
		7.0	ZM44007	
		8.5	ZM44085	
		10.0	ZM44010	
		11.5	ZM44011	
		13.0	ZM44013	
4.30	3.70/3.30	6.0	ZM44306	
		7.0	ZM44307	
		8.5	ZM44385	
		10.0	ZM44310	
		11.5	ZM44311	
		13.0	ZM44313	
4.60	3.90/3.55	6.0	ZM44606	
		7.0	ZM44607	
		8.5	ZM44685	
		10.0	ZM44610	
		11.5	ZM44611	
5.00	4.15/3.75	6.0	ZM45006	
		7.0	ZM45007	
		8.5	ZM45085	
		10.0	ZM45010	
			11.5	ZM45011
			13.0	ZM45013

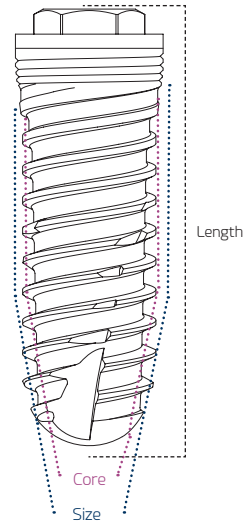

Cover screw*



Platf.	Length (L)	Reference
NP	5.00	OEXNPT
RP	5.00	OEXRPT
WP	4.90	OEXWPT

Anodised NP RP WP



* Screw included with each implant.

Metric



Metrics 1.80 (NP) and 2.00 (RP/WP).

Platform

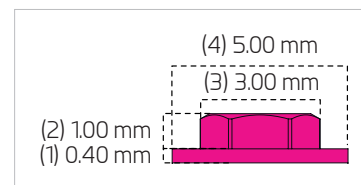
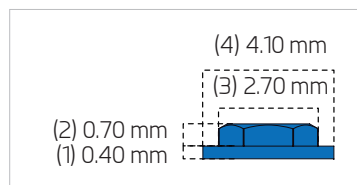
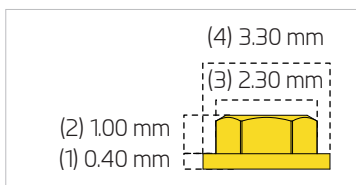

(1) Untreated machined zone. (2) External hex height. (3) Distance between faces of the external hex. (4) Diameter of working platform.

Recommendations for use

All implant treatments must respect the natural biomechanical stability of the oral cavity and allow the natural emergence of the dental crown through the soft tissue. The implantologist must assess the quantity and quality of bone currently in the implant area and consider the need for prior or simultaneous bone regeneration, as appropriate.

Ziacom® has a wide range of implants available to cover every restoration possibility. The squares on the odontogram shown represent the implant diameters and platforms recommended for each tooth position.

These recommendations are valid for the replacement of teeth with single restorations, bridges, hybrid work or overdentures.

Remember to maintain minimum distances between adjacent implants and between implants and teeth in order to preserve interdental papilla, bone vascularisation and natural emergence profiles.

Selection of the appropriate implant for each case is the sole responsibility of the implantologist. Ziacom® advises all clinicians to take into account the warnings based on scientific evidence which can be found in the product catalogues and our website.

■ CLARIFICATIONS ON DRILLING MEASUREMENTS AND TECHNIQUES

- **IMPLANT SIZE:** identifies the diameter and length of the implant.
- **IMPLANT BODY:** diameter of the implant core.
- **DRILL SIZE:** corresponds to drill diameter.
- **DRILLING TECHNIQUE:** We have developed various drilling protocols as a blueprint for dealing with different situations that arise when performing implant surgery.

For more information on implant size selection, see the literature available at www.ziacom.com/biblioteca

Dental chart

ZM4

Implant diameter⁽¹⁾

■ NP ■ A RP ■ B RP ■ C RP ■ WP ■ WP
 Ø3.30 mm Ø3.70 mm Ø4.00 mm Ø4.30 mm Ø4.60 mm Ø5.00 mm

(1) Diameters available for analogue platforms.

Implant crown diameter

■ NP ■ RP ■ WP
 Ø3.30 mm Ø4.10 mm Ø5.00 mm

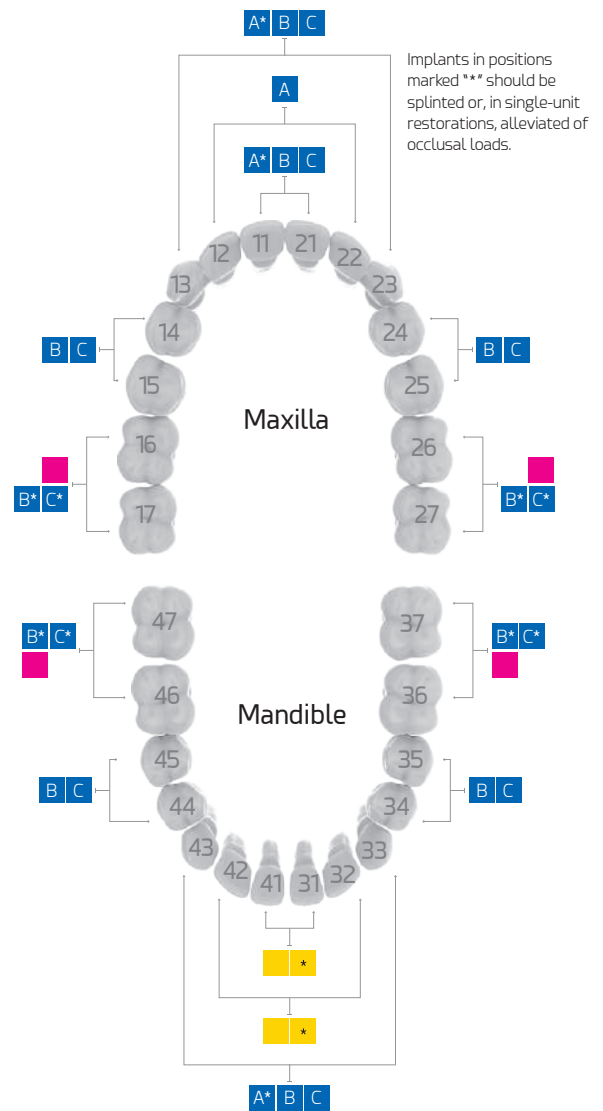

How to use this catalogue

Product data sheet

Title, section and paragraph

Product name

Product image

Product table:
 - Platform
 - System
 - Height (H)
 - Diameter (∅)
 - Reference

All the dimensions given in this catalogue are expressed in millimetres (mm)

Abutments
 Direct-to-implant restorations

2nd STAGE AND IMPRESSIONS

Healing abutment

Platt.	Height H ¹	Reference
1	150	HAEK2015
2	300	HAEK2030
3	500	HAEK2050
4	7,00	HAEK2070
5	150	HAEK415
6	300	HAEK430
7	500	HAEK450
8	7,00	HAEK470
9	150	HAEK515
10	300	HAEK530
11	500	HAEK550
12	7,00	HAEK570

Impression abutment

Platt.	Height H ¹	Reference
1	1180	TCEX2011
2	1180	TCEX4111
3	7,80/Short	TCEX402
4	1180	TCEX5011
5	7,80/Short	TCEX5002

Impression abutment screw

Platt.	Height H ¹	Reference
1	0,00	LTS52000
2	3,00	LTS52001
3	6,00	LTS52002
4	9,00	LTS52010
5	0,00	LTS53400
6	3,00	LTS53401
7	6,00	LTS53402
8	9,00	LTS53410
9	0,00	LTS53400*

Impression abutment screw - Quickly Screws

Platt.	Height H ¹	Reference
1	3,00	LT2001
2	6,00	LT2002
3	3,00	LT3401
4	6,00	LT3402

Product line diagram

Product characteristics

Additional information

*Screens to take fast impressions with short impression transfer.

www.ziacom.com

Symbology

Symbol	Meaning	Symbol	Meaning	Symbol	Meaning
	Rotatory element		Tx30 connection		Made from steel
	Non-rotatory element		Size in millimetres		Made from cobalt-chromium + castable plastic
	Use with manual torque (see table on p. 38).		45° screw support		Made from cobalt-chromium
	Maximum operating torque		90° screw support		Made from PEEK
	Ratchet torque range		Use in rotation with a CA		Made from castable plastic
	Galaxy connection		Maximum rotation speed		Made from plastic
	Screw connection		Maximum number of uses		Recommended sterilisation temperature
	Kirator connection		Single-use product		Unsterilised product
	Nature connection		Made from grade 5 ELI (extra-low interstitial) titanium		Use with abundant irrigation
	Basic connection		Made from grade 2 titanium		Maximum angle
	XDrive connection		Made from stainless steel		

Abutments

Direct-to-implant
reconstructions



Abutments

Direct-to-implant restorations

2nd STAGE AND IMPRESSIONS

Healing abutment

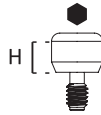

Platf.	Height (H)	Reference
■	1.50	HAEX2015
■	3.00	HAEX2030
■	5.00	HAEX2050
■	7.00	HAEX2070
■	1.50	HAEX3415
■	3.00	HAEX3430
■	5.00	HAEX3450
■	7.00	HAEX3470
■	1.50	HAEX5015
■	3.00	HAEX5030
■	5.00	HAEX5050
■	7.00	HAEX5070

Anodised ■ NP ■ RP ■ WP



Impression abutment

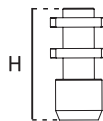

Platf.	Height (H)	Reference
■	11.80	TCEX2011
■	11.80	TCEX3411
■	7.80/Short	TCEX3402
■	11.80	TCEX5011
■	7.80/Short	TCEX5002

Anodised ■ NP ■ RP ■ WP



Impression abutment screw

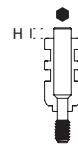

Platf.	Height (H)	Reference
■	0.00	LTSS2000
■	3.00	LTSS2001
■	6.00	LTSS2002
■	9.00	LTSS2010
■ ■	0.00	LTSS3400
■ ■	3.00	LTSS3401
■ ■	6.00	LTSS3402
■ ■	9.00	LTSS3410
■ ■	0.00	STSS3400*

Anodised ■ NP ■ RP/WP



*Screws to take fast impressions with short impression transfer.

Impression abutment screw - Quickly Screws

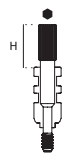

Platf.	Height (H)	Reference
■	3.00	LT2001
■	6.00	LT2002
■ ■	3.00	LT3401
■ ■	6.00	LT3402

Anodised ■ NP ■ RP/WP



Height (H) is calculated with regard to normal impression abutment height. When using a short impression abutment, consider the difference between the heights of the abutments.

Pick-up impression abutment



Platf.	Height (H)	Reference
	1.60	PUEX2000
	1.60	PUEX3400
	1.60	PUEX5000

Anodised NP RP WP



Pick-up impression transfer

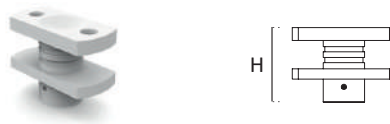

Platf.	Height (H)	Reference
	7.25	CPU3410



Pack of 4 units. DO NOT sterilise in an autoclave. Drillable.

Z2Plus Snap-On impression abutment



Platf.	Height (H)	Reference
	1.50	Z2NPEX10
	1.50	Z2RPEX10
	1.50	Z2WPEX10

Anodised NP RP WP



IMPORTANT

Use the laboratory screw to tighten this impression abutment.

Z2Plus Snap-On impression transfer



Platf.	Height (H)	Reference
	8.00	ZPU3400
	8.00	ZPU5000



Pack of 4 units. DO NOT sterilise in an autoclave. Drillable.

Implant analogue



Platf.	Length (L)	Reference
	12.00	IAEX2000
	12.30	IAEX3400
	12.00	IAEX5000



3D implant analogue - Individual



Platf.	Length (L)	Reference
	13.00	IAEX2008D
	13.00	IAEX3408D
	13.00	IAEX5008D



3D implant analogue - Pack

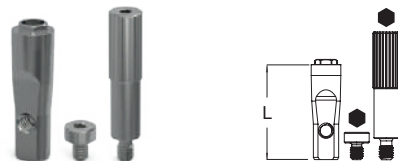

Platf.	Length (L)	Reference
	13.00	IAEX2008DC*
	13.00	IAEX3408DC*
	13.00	IAEX5008DC*



*Includes base screw Ref. DSIADI and lateral screw Ref. DSIADT for analogue connection.

Screws - 3D Analogue

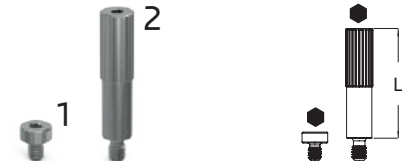

Type	Length (L)	Reference
Base screw (1)*	-	DSIADI
Lateral screw (2)*	15.00	DSIADT



*Pack of 4 units.

Abutments

FASTENING COMPONENTS

Clinical screw



Platf.	Length (L)	Reference
■	8.30	DSEI2000
■ ■	8.30	DSEI3400

Anodised ■ NP ■ RP/WP



Kiran clinical screw



For ZiaCam Ti-Base or metal structures

Platf.	Length (L)	Reference
■	8.30	DSEI2010
■ ■	8.30	DSEI3410



Special Kiran screw with surface treatment.

Laboratory screw



Platf.	Length (L)	Reference
■	7.40	LB102000
■ ■	7.40	LB103400



NOT suitable for use as the final clinical screw.

Kiran Tx30 clinical screw



For ZiaCam Tx30 abutments and Ti-Base

Platf.	Length (L)	Reference
■	6.80	DSEI2010TX
■ ■	6.80	DSEI3410TX



Special Kiran screw with surface treatment.

Use only with Tx30 screwdrivers.

PROVISIONAL

Provisional abutment



Rotatory

Platf.	Length (L)	Reference
■	9.50	RUEXT2010
■	9.50	RUEXT3410
■	9.50	RUEXT5010

Anodised ■ NP ■ RP ■ WP



Non-Rotatory

Platf.	Length (L)	Reference
■	9.50	NUEXT2010
■	9.50	NUEXT3410
■	9.50	NUEXT5010

Anodised ■ NP ■ RP ■ WP



Provisional abutment

Aesthetic and immediate loading abutments



Rotatory

Platf.	Length (L)	Reference
■	9.50	RUEXP2010
■	9.50	RUEXP3410
■	9.50	RUEXP5010



Non-Rotatory

Platf.	Length (L)	Reference
■	9.50	NUEXP2010
■	9.50	NUEXP3410
■	9.50	NUEXP5010



SCREWED

■ **UCLA**

UCLA

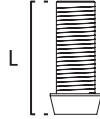

Rotatory

Platf.	Length (L)	Reference
■	11.00	RUEX2000
■	11.00	RUEX3400
■	11.00	RUEX5000



Non-rotatory

Platf.	Length (L)	Reference
■	11.00	NUEX2000
■	11.00	NUEX3400
■	11.00	NUEX5000



■ **MACHINED BASE UCLA**

**Machined base abutment
+ Castable abutment**



Rotatory

Platf.	Length (L)	Reference
■	10.60	BRUEX20
■	10.60	BRUEX34
■	10.60	BRUEX50



Non-rotatory

Platf.	Length (L)	Reference
■	10.60	BNUEX20
■	10.60	BNUEX34
■	10.60	BNUEX50



Abutments

SCREWED

■ Tx30 VARIABLE ROTATION ABUTMENT

Mach. base abutment Tx30
+ 2 castable abutments (15° and 20°)



Rotatory

Platf.	15° Length (L)	20° Length (L)	Reference
■	11.40	11.20	BRUEX20TX
■	11.40	11.20	BRUEX34TX
■	11.40	11.20	BRUEX50TX



Non-rotatory

Platf.	15° Length (L)	20° Length (L)	Reference
■	11.40	11.20	BNUEX20TX
■	11.40	11.20	BNUEX34TX
■	11.40	11.20	BNUEX50TX



Mach. base abutment Tx30
+ 2 castable abutments (20° and 25°)



Rotatory

Platf.	20° Length (L)	25° Length (L)	Reference
■	11.20	11.00	BRUEX20TX1
■	11.20	11.00	BRUEX34TX1
■	11.20	11.00	BRUEX50TX1



Non-rotatory

Platf.	20° Length (L)	25° Length (L)	Reference
■	11.20	11.00	BNUEX20TX1
■	11.20	11.00	BNUEX34TX1
■	11.20	11.00	BNUEX50TX1



Includes special Kiran Tx30 screw with surface treatment Ref. DSEI2010TX (NP)/DSEI3410TX (RP/WP) for all Tx30 Variable Rotation abutments.

■ TX30 VARIABLE ROTATION ABUTMENT

The Tx30 variable rotation abutment comprises a Cr-Co machined base that accepts 15°, 20° or 25° angled castable abutments and a Kiran clinical screw with a special Tx30 connection.

The Cr-Co base ensures a perfect fit and seal with the implant connection and the different angles of the castable abutments can be used to choose the best position for the correct emergence of the restoration screw access channel.

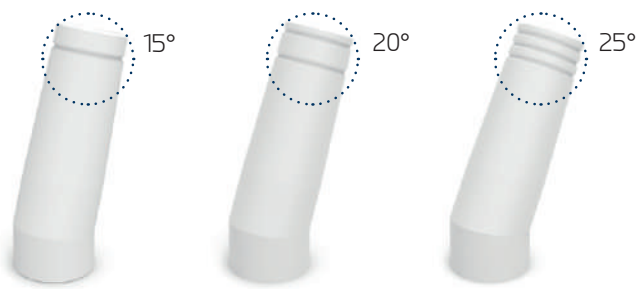

Identifying grooves for the castable angles



CEMENTED

Straight Abutment

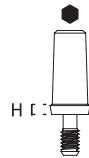

Platf.	Height (H)	Reference
■	1.50	STAEX2015
■	2.50	STAEX2025
■	3.50	STAEX2035
■	1.50	STAEX3415
■	2.50	STAEX3425
■	3.50	STAEX3435
■	1.50	STAEX5015
■	2.50	STAEX5025
■	3.50	STAEX5035

Anodised ■ NP ■ RP ■ WP



Straight Abutment



Platf.	Height (H)	Reference
■	1.50	STEX2015
■	2.50	STEX2025
■	3.50	STEX2035
■	1.50	STEX3415
■	2.50	STEX3425
■	3.50	STEX3435
■	1.50	STEX5015
■	2.50	STEX5025
■	3.50	STEX5035

Anodised ■ NP ■ RP ■ WP



15° angled abutment



Platf.	Height (H)	Prod. code
■	1.50	A1EX2015
■	2.50	A2EX2015
■	1.50	A1EX3415
■	2.50	A2EX3415
■	1.50	A1EX5015
■	2.50	A2EX5015

Anodised ■ NP ■ RP ■ WP



25° angled abutment



Platf.	Height (H)	Prod. code
■	1.50	A1EX2025
■	2.50	A2EX2025
■	1.50	A1EX3425
■	2.50	A2EX3425
■	1.50	A1EX5025
■	2.50	A2EX5025

Anodised ■ NP ■ RP ■ WP



Abutments

Direct-to-implant restorations

OVERDENTURES

Kirator



Kirator abutment with applicator



Kirator abutment

Platf.	Height (H)	Reference
■	1.00	LOEX2001
■	2.00	LOEX2002
■	3.00	LOEX2003
■	4.00	LOEX2004
■	5.00	LOEX2005
■	6.00	LOEX2006
■	1.00	LOEX3401
■	2.00	LOEX3402
■	3.00	LOEX3403
■	4.00	LOEX3404
■	5.00	LOEX3405
■	6.00	LOEX3406
■	1.00	LOEX5001
■	2.00	LOEX5002
■	3.00	LOEX5003
■	4.00	LOEX5004

Golden surface treatment.

Insertion key Ref. LOSD01/LOSD02



Includes the Kirator abutment with sterilisable polyoxymethylene applicator (Tecaform AH-POM-C).

Related abutments

Kirator impression transfer

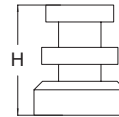

System	Height (H)	Reference
Kirator	6.50	TCRK3400



Pack of 4 units. DO NOT sterilise in an autoclave. Drillable.

Kirator analogue

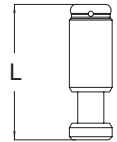

System	Length (L)	Reference
Kirator	13.00	IATORK01



Kirator processing kit

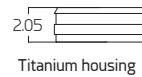

System	Reference
Kirator processing kit	TP8520

Kirator processing kit consisting of: Titanium housing with black relined cap, spacer and purple, transparent and pink plastic caps.

Sterilise the metal coping in an autoclave. Plastic caps and the disc should be cold sterilised. See Instructions for Cleaning and Sterilising on the Ziacom® website.

System	Retention (kg)	Reference
Kirator	Light/1.20 kg	TPK100
	Standard/1.80 kg	TPK200
	Strong/2.70 kg	TPK300

Pack of 4 plastic Kirator retainer caps.



NOT autoclavable – use cold steriliser. Maximum divergence of 22° between implants.

Kirator divergence processing kit

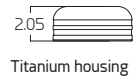

System	Reference
Kirator processing kit	TP8520D

Kirator divergence processing kit comprising: Titanium housing with black relined cap, spacer and purple, clear and pink plastic caps.

Sterilise the metal coping in an autoclave. Plastic caps and the disc should be cold sterilised. See Instructions for Cleaning and Sterilising on the Ziacom® website.

System	Retention (kg)	Reference
Kirator	Light/1.20 kg	TPK110
	Standard/1.80 kg	TPK220
	Strong/2.70 kg	TPK330

Pack of 4 plastic Kirator retainers caps - Divergent.



NOT autoclavable – use cold steriliser. Maximum divergence of 44° between implants.

Example sequence



ZM-Equator



ZM-Equator abutment with applicator



ZM-Equator abutment

Platf.	Height (H)	Reference
■	1.00	ZMEX2001
■	2.00	ZMEX2002
■	3.00	ZMEX2003
■	4.00	ZMEX2004
■	5.00	ZMEX2005
■	6.00	ZMEX2006
■	1.00	ZMEX3401
■	2.00	ZMEX3402
■	3.00	ZMEX3403
■	4.00	ZMEX3404
■	5.00	ZMEX3405
■	6.00	ZMEX3406
■	1.00	ZMEX5001
■	2.00	ZMEX5002
■	3.00	ZMEX5003
■	4.00	ZMEX5004

Golden surface treatment



Includes ZM-Equator abutment with sterilisable polyoxymethylene plastic applicator (Tecaform AH-POM-C).

Related abutments

ZM-Equator impression transfer

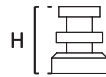

System	Height (H)	Reference
ZM-Equator	6.50	TCRK3410



Pack of 4 units. DO NOT sterilise in an autoclave. Drillable.

ZM-Equator analogue

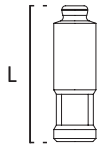

System	Length (L)	Reference
ZM-Equator	13.20	IAZM01



ZM-Equator processing kit



Titanium housing

System	Reference
ZM-Equator processing kit	ZM8520

ZM-Equator processing kit consisting of: Titanium housing with black relined cap, spacer and three plastic caps in purple, transparent and pink.

Sterilise the metal coping in an autoclave. Plastic caps and the disc should be cold sterilised. See Instructions for Cleaning and Sterilising on the Ziacom® website.

System	Retention (kg)	Reference
ZM-Equator	Light/1.20 kg	TZM100
	Standard/1.80 kg	TZM200
	Strong/2.70 kg	TZM300

Pack of 4 plastic ZM-Equator retainer caps.



NOT autoclavable – use cold steriliser. Maximum divergence of 22° between implants.

ZM-Equator divergence processing kit

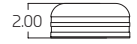

Titanium housing

System	Reference
ZM-Equator processing kit	ZM8520D

ZM-Equator divergence processing kit comprising: Titanium housing with black relined cap, spacer and three plastic caps in purple, transparent and pink.

Sterilise the metal coping in an autoclave. Plastic caps and the disc should be cold sterilised. See Instructions for Cleaning and Sterilising on the Ziacom® website.

System	Retention (kg)	Reference
ZM-Equator	Light/1.20 kg	TZM100
	Standard/1.80 kg	TZM200
	Strong/2.70 kg	TZM300

Pack of 4 plastic ZM-Equator retainer caps - Divergent.



NOT autoclavable – use cold steriliser. Maximum divergence of 44° between implants.

Example sequence



Abutments

DIGITAL CAD-CAM

ZiaCam scanbody to implant

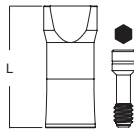

See the literature available at www.ziacom.com/biblioteca for more information on the use of zirconium restoration interfaces or the use of abutments in the "Prosthetic procedure" manual.



Platf.	Length (L)	Reference
Yellow	10.00	FNSYEX208T
Blue	10.00	FNSYEX348T
Pink	10.00	FNSYEX508T



Indicated for clinical and laboratory use.

All ZiaCam scanbodies to implant abutments include a screw Ref. LB102000 (NP)/LB103400 (RP/WP).

ZiaCam Ti-Base

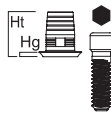
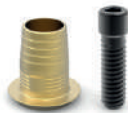

Rotatory

Platf.	Height (Hg/Ht)	Reference
Yellow	0.50/5.00	FRUEX201
Yellow	1.50/6.00	FRUEX202
Blue	0.50/5.00	FRUEX341
Blue	1.50/6.00	FRUEX342
Pink	0.50/5.00	FRUEX501
Pink	1.50/6.00	FRUEX502



Non-Rotatory

Platf.	Height (Hg/Ht)	Reference
Yellow	0.50/5.00	FNUEX201
Yellow	1.50/6.00	FNUEX202
Blue	0.50/5.00	FNUEX341
Blue	1.50/6.00	FNUEX342
Pink	0.50/5.00	FNUEX501
Pink	1.50/6.00	FNUEX502



All ZiaCam Ti-Base abutments come with a special Kiran screw with surface treatment Ref. DSEI2010 (NP)/DSEI3410 (RP/WP).

Tx30 ZiaCam Ti-Base

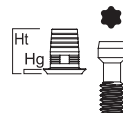

Rotatory

Platf.	Height (Hg/Ht)	Reference
Yellow	0.50/6.00	FRUEX20TX1
Yellow	1.50/7.00	FRUEX20TX2
Blue	0.50/6.00	FRUEX34TX1
Blue	1.50/7.00	FRUEX34TX2
Pink	0.50/6.00	FRUEX50TX1
Pink	1.50/7.00	FRUEX50TX2



Non-Rotatory

Platf.	Height (Hg/Ht)	Reference
Yellow	0.50/6.00	FNUEX20TX1
Yellow	1.50/7.00	FNUEX20TX2
Blue	0.50/6.00	FNUEX34TX1
Blue	1.50/7.00	FNUEX34TX2
Pink	0.50/6.00	FNUEX50TX1
Pink	1.50/7.00	FNUEX50TX2



All Tx30 ZiaCam Ti-Base abutments come with a special Kiran Tx30 screw with surface treatment Ref. DSEI2010TX (NP)/DSEI3410TX (RP/WP).

Kirator. Toolbar abutment

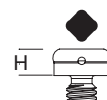

Platf.	Height (H)	Reference
Universal	1.80	LOTB100

Golden surface treatment.



Abutments

Restorations
using transepithelials



Abutments

Restorations using transepithelials

■ Transepithelial abutments

- Allows the peri-implant tissue to form from the initial 8 weeks.
- One abutment-one time, allows gingival adhesion to its surface as repeated detachments are not necessary.
- Avoids bone and soft tissue loss as there is no mechanical rupture of the peri-implant interface.
- The prosthetic working area is above the gingival level, making the soft tissue adhesive behaviour more predictable, maintaining a good seal.
- Less formation of micro-gaps at the implant-prosthesis junction.
- Increased crestal bone preservation.
- Prosthetic try-ins and definitive placement without anaesthesia.
- If the recommended torques are exceeded, the screw suffers the fracture at transepithelial level and not inside the implant.

■ Abutment heights

- Greater abutment height means more marginal bone is preserved in cement-retained prostheses.
- Higher abutments ($\geq 2\text{mm}$) provide better soft tissue adaptation.
- Short abutments ($< 2\text{ mm}$) can compromise the soft tissues, resulting in more crestal bone loss.
- Marginal bone loss will differ depending on the clinical decision on the abutment height. Generally, prosthetic abutments $\geq 2\text{mm}$ will lead to better preservation of crestal bone.

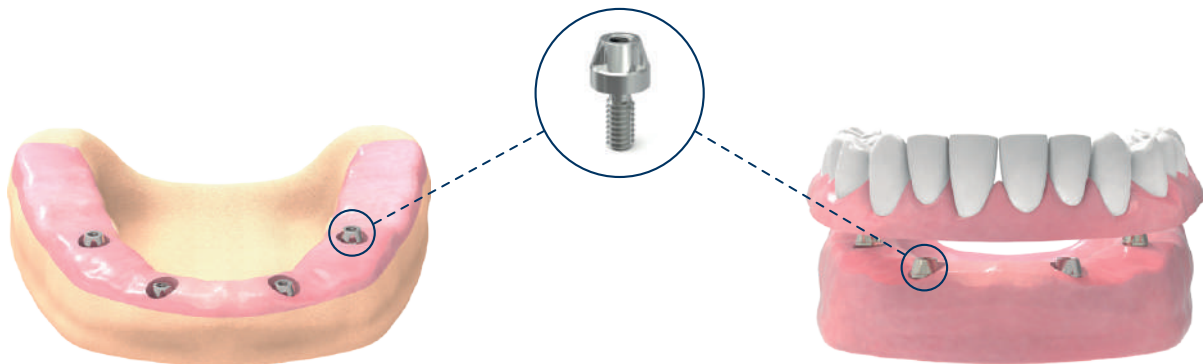

■ Basic | Example of usage sequence

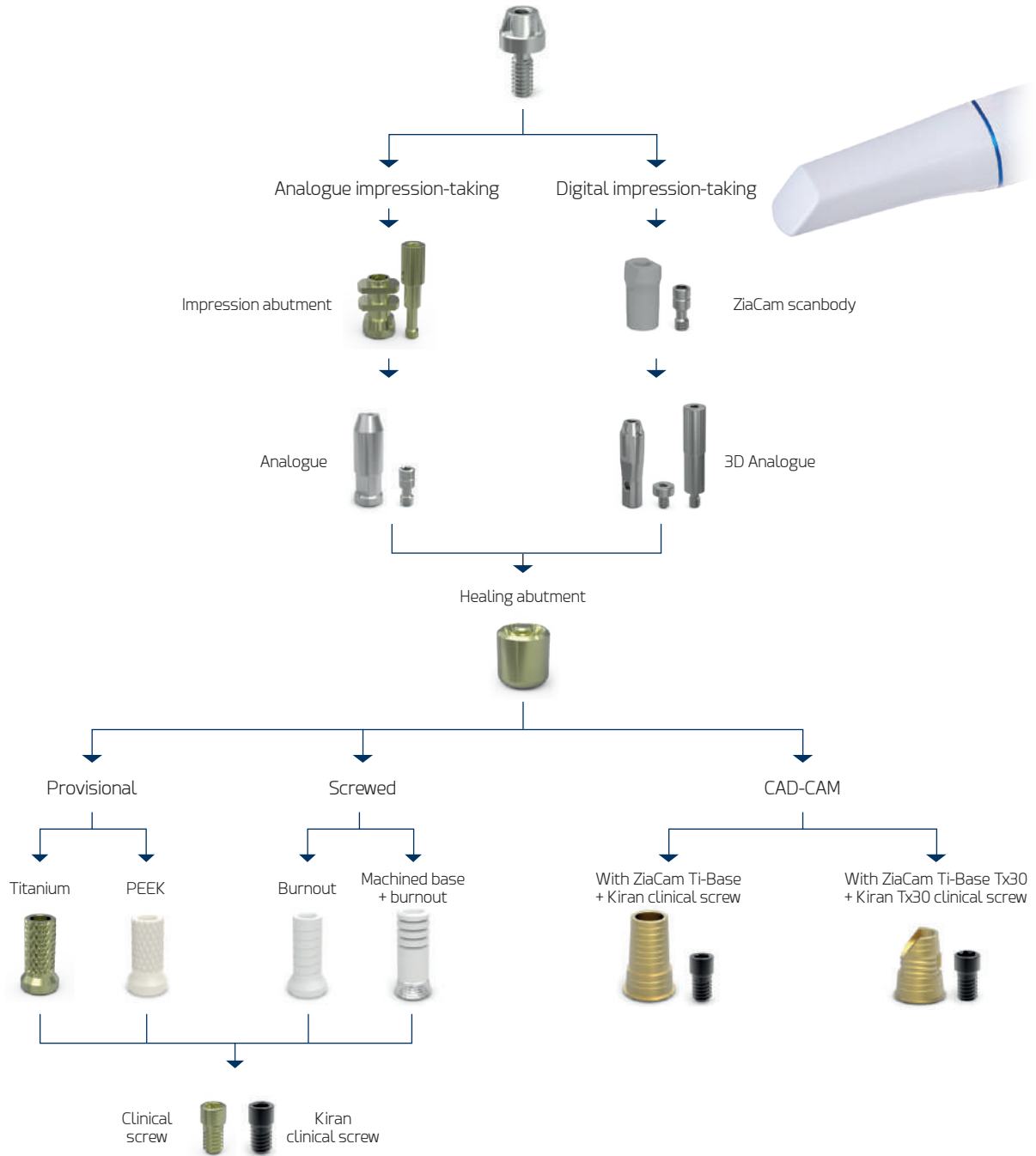

For more information on the use of abutments, see the "Prosthetic procedure manual" available at www.ziacom.com/biblioteca



Abutments

Basic abutment



Platf.	Height (H)	Reference
■	2.00	BASIC2002
■	3.00	BASIC2003
■	4.00	BASIC2004
■	5.00	BASIC2005
■	1.50	BASIC3401
■	2.00	BASIC3402
■	3.00	BASIC3403
■	4.00	BASIC3404
■	5.00	BASIC3405
■	2.00	BASIC5002
■	3.00	BASIC5003
■	4.00	BASIC5004
■	5.00	BASIC5005



Basic abutment with applicator

Insertion key Ref. MABA100/MABA110.



Includes the Basic abutment with sterilisable polyoxymethylene applicator (Tecaform AH-POM-C). 18° cone angle. 36° angle between abutments.

Basic healing abutment

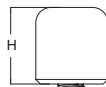

System	Height (H)	Reference
Basic	5.00	BAHAEX34

Anodised ■



Basic impression abutment



System	Height (H)	Reference
Basic	8.00	BATC134

Anodised ■



All Basic impression abutments come with a screw.

Basic analogue

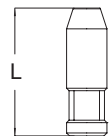

System	Length (L)	Reference
Basic	13.00	BAIAEX34



Basic 3D analogue - Individual

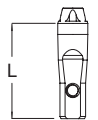

System	Length (L)	Reference
Basic	13.00	BAIA348D



Basic 3D analogue - Pack

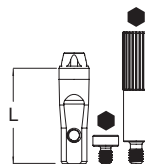

System	Length (L)	Reference
Basic	13.00	BAIA348DC*



*Includes base screw Ref. DSIADI and lateral screw Ref. DSIADT for analogue connection.

Screws - 3D Analogue

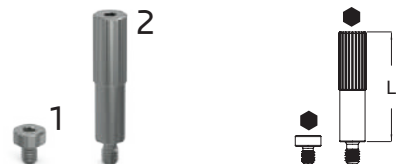

Type	Length (L)	Reference
Base screw (1)*	-	DSIADI
Lateral screw (2)*	15.00	DSIADT



*Pack of 4 units.

Basic clinical screw



System	Length (L)	Reference
Basic	4.30	BDSEI3400

Anodised ■



Kiran Basic clinical screw



System	Length (L)	Reference
Basic	4.30	BDSEI3410



Special Kiran screw with surface treatment.

Basic laboratory screw



System	Length (L)	Reference
Basic	5.50	BDSEI3401



NOT suitable for use as the final clinical screw.

Kiran Tx30 Basic clinical screw



System	Length (L)	Reference
Basic	4.10	BDSEI34TX



Special Kiran Tx30 screw with surface treatment.

Basic provisional abutment

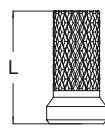

System	Length (L)	Reference
Basic	8.50	BARUT10

Anodised ■



Basic provisional abutment

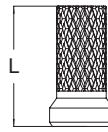

System	Length (L)	Reference
Basic	8.50	BARUP34



Basic UCLA

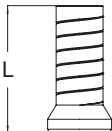

System	Length (L)	Reference
Basic	9.00	BARUEX34



Machined base abutment Basic + Castable abutment

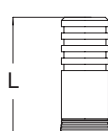

System	Length (L)	Reference
Basic	11.00	BBRU34



Abutments

DIGITAL CAD-CAM

ZiaCam scanbody to Basic abutment

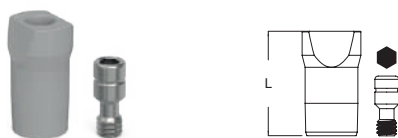

System	Length (L)	Reference
Basic	8.70	FNSYB18T



Indicated for clinical and laboratory use.

All ZiaCam scanbodies to Basic abutments include a screw Ref. BDSEI3401.

ZiaCam Ti-Base to Basic



System	Height (Hg/Ht)	Reference
Basic	0.30/6.70	BFRU341



All Ti-Base ZiaCam to Basic abutments come with a special Kiran screw with surface treatment Ref. BDSEI3410.

ZiaCam Ti-Base Tx30 to Basic



System	Height (Hg/Ht)	Reference
Basic	0.30/5.70	BFRU341TX



All ZiaCam Ti-Base Tx30 to Basic abutments come with a special Kiran Tx30 screw with surface treatment Ref. BDSEI34TX.

Restorations using transepithelials

■ XDrive | Example of usage sequence

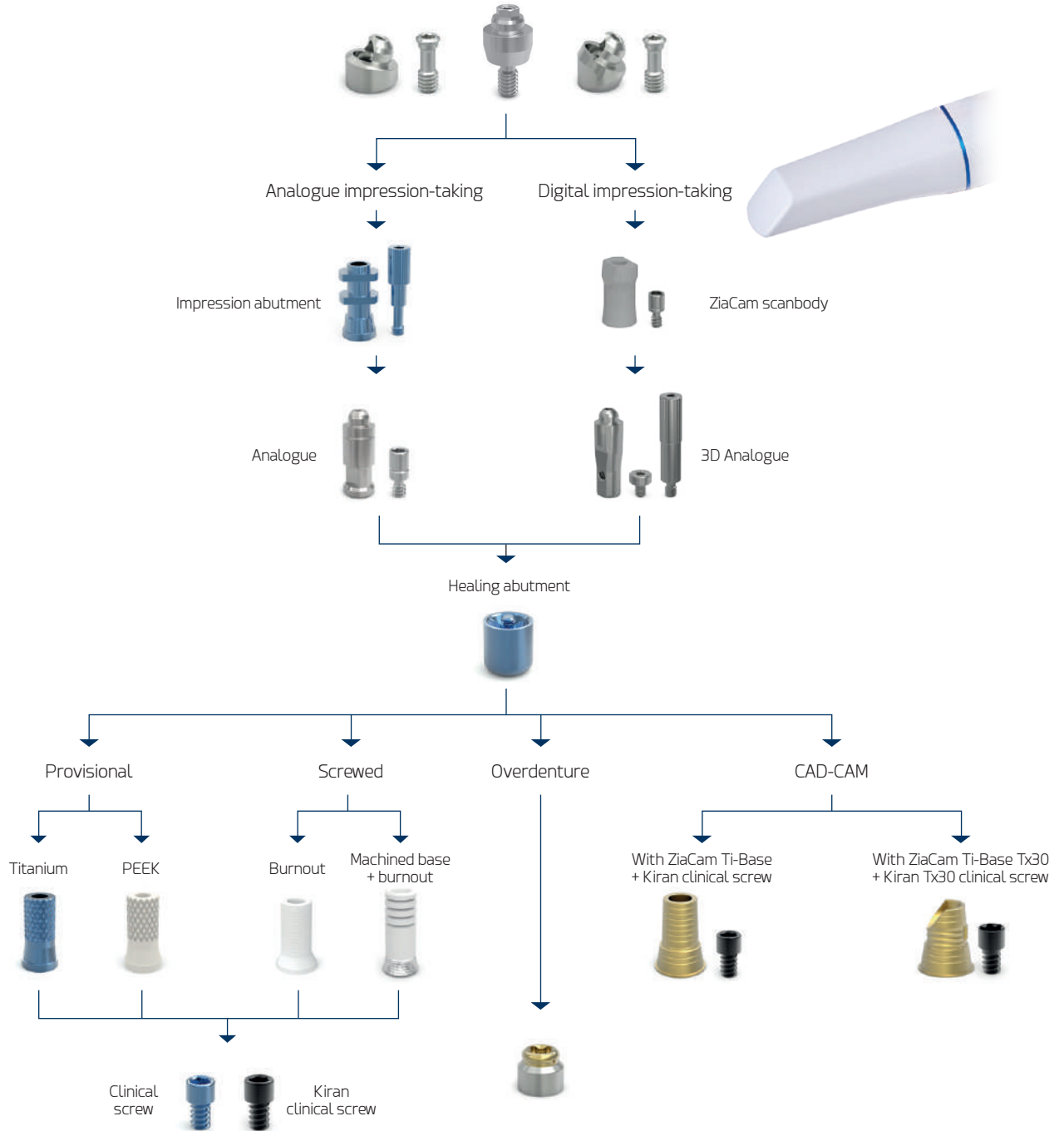

For more information on the use of abutments, see the "Prosthetic procedure manual" available at www.ziacom.com/biblioteca

Abutments

XDrive straight abutment



Platf.	Height (H)	Reference
■	1.00	XST103410
■	2.00	XST103420
■	3.00	XST103430
■	4.00	XST103440
■	5.00	XST103450

Insertion key Ref. MABA200/MABA210



Includes XDrive abutment with sterilisable polyoxymethylene applicator (Tecaform AH-POM-C).

21° cone angle. 42° angle between abutments.



XDrive abutment with applicator

XDrive 17° angled abutment



Platf.	Height (H)	Reference
■	2.00	XA2103417
■	3.00	XA3103417
■	4.00	XA4103417
■	5.00	XA5103417



All XDrive angled abutments come with a titanium positioner and screw.

XDrive 30° angled abutment



Platf.	Height (H)	Reference
■	3.00	XA3103430
■	4.00	XA4103430
■	5.00	XA5103430



XDrive healing abutment



System	Height (H)	Reference
XDrive	5.00	XH103400

Anodised ■



XDrive impression abutment



System	Height (H)	Reference
XDrive	10.50	XT103411

Anodised ■



Includes screw.

XDrive analogue



System	Length (L)	Reference
XDrive	13.00	XIA103400



XDrive 3D analogue - Individual



System	Length (L)	Reference
XDrive	13.00	XIA3408D



XDrive 3D analogue - Pack



System	Length (L)	Reference
XDrive	13.00	XIA3408DC*



*Includes base screw Ref. DSIADI and lateral screw Ref. DSIADT for analogue connection.

Screws - 3D Analogue

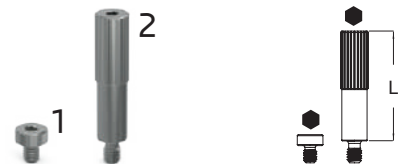

Type	Length (L)	Reference
Base screw (1)*	-	DSIADI
Lateral screw (2)*	15.00	DSIADT



*Pack of 4 units.

XDrive clinical screw

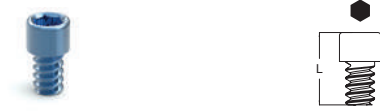

System	Length (L)	Reference
XDrive	3.50	XDS103410

Anodised ■



Kiran XDrive clinical screw



System	Length (L)	Reference
XDrive	3.50	XDS103411



Special Kiran screw with surface treatment.

XDrive laboratory screw



System	Length (L)	Reference
XDrive	5.10	XLB103410



NOT suitable for use as the final clinical screw.

Kiran Tx30 XDrive clinical screw



For ZiaCam Ti-Base or metal structures

System	Length (L)	Reference
XDrive	3.50	XDS3411TX



Kiran Tx30 special screw with surface treatment.

XDrive provisional abutment



System	Length (L)	Reference
XDrive	9.50	XST3410

Anodised ■



XDrive provisional abutment

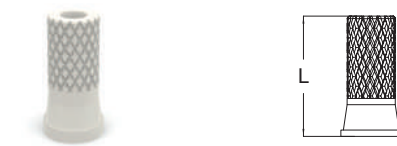

System	Length (L)	Reference
XDrive	9.50	XSP3410



XDrive

XDrive UCLA abutment

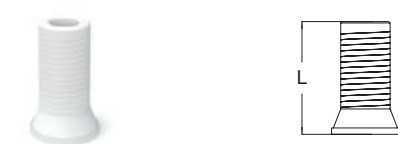

System	Length (L)	Reference
XDrive	8.00	XRU103400



Machined base abutment XDrive + Castable abutment



System	Length (L)	Reference
XDrive	11.00	XBRU34



Kirator XDrive abutment



System	Height (Hg/Ht)	Reference
XDrive	3.00/4.30	XLO3400

Kirator abutment with gold surface treatment.



Abutments

DIGITAL CAD-CAM

ZiaCam scanbody to XDrive abutment

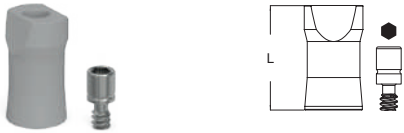

System	Length (L)	Reference
XDrive	8.70	FNSYX18T



Indicated for clinical and laboratory use.

All ZiaCam scanbodies to XDrive abutments include a screw Ref. XLB103410.

ZiaCam XDrive Ti-Base



System	Height (Hg/Ht)	Reference
XDrive	0.15/6.70	XFRU341



Includes special Kiran screw with surface treatment Ref. XDS103411.

ZiaCam Ti-Base Tx30 XDrive



System	Height (Hg/Ht)	Reference
XDrive	0.15/5.70	XFRU341TX



Includes special Kiran Tx30 screw with surface treatment Ref. XDS3411TX.

Table of abutment torques

Element/Abutment	Instrument/Tool	Torque
Cover screws/Healing abutments	Hex screwdriver 1.25 mm	Manual
Impression abutment screws	Hex screwdriver 1.25 mm	Manual
Laboratory screws	Hex screwdriver 1.25 mm	Manual
Direct-to-implant clinical screws	Hex screwdriver 1.25 mm	30 Ncm
Kiran direct-to-implant clinical screws	Hex screwdriver 1.25 mm	30 Ncm
Nature abutments	Insertion keys: MANA100/MANA110/MANA120	30 Ncm
Clinical screws on Nature	Hex screwdriver 1.25 mm	30 Ncm
Kiran clinical screws on Nature	Hex screwdriver 1.25 mm	30 Ncm
Basic abutments	Insertion keys: MABA100/MABA110/MABA120	30 Ncm
XDrive abutments	Insertion keys: MABA200/MABA210/MABA220	30 Ncm
Clinical screws on Basic	Hex screwdriver 1.25 mm	25 Ncm
Kiran clinical screws on Basic	Hex screwdriver 1.25 mm	25 Ncm
Clinical screws on XDrive	Hex screwdriver 1.25 mm	20 Ncm
Kiran clinical screws on XDrive	Hex screwdriver 1.25 mm	20 Ncm
ZiaCam scanbody + screw	Hex screwdriver 1.25 mm	Manual
Kirator abutments	Insertion keys: LOSD01/LOSD02	30 Ncm
Tx30 abutment/screw (variable rotation)	Torx. screwdriver Tx30	30 Ncm

WARNING
Exceeding the recommended tightening torque for screws and abutments compromises the prosthetic restoration and could damage the implant structure.

i For immediate loading: DO NOT tighten manually, attach with the final torque. When using a screwdriver or adaptor for a contra-angle handpiece (CA), do not exceed a maximum speed of 25 rpm.

Surgical
instruments

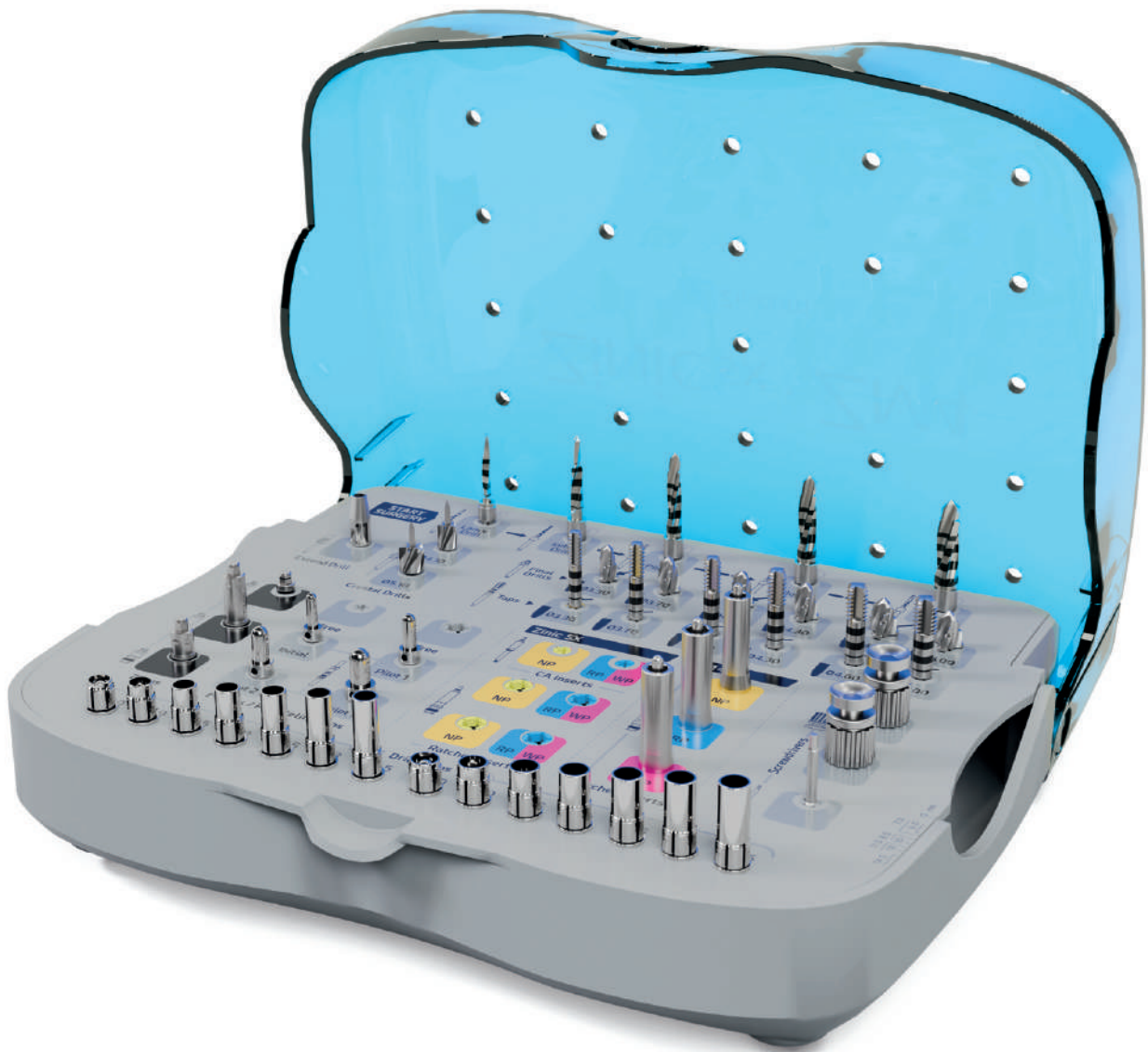

Surgical instruments

Zinic® SX - ZM4 surgical box

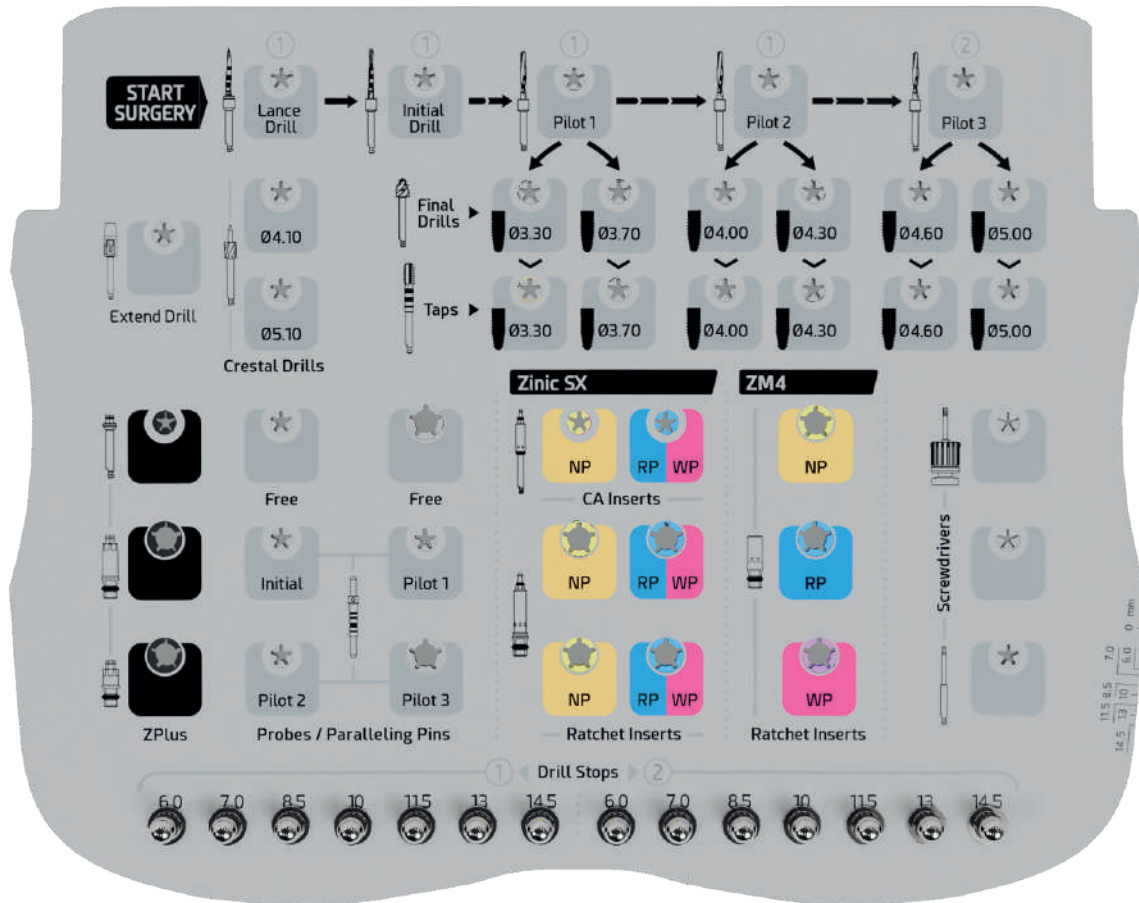

■ Zinic® SX - ZM4 contents available

Platf.	Contents	Reference
	Empty	BOX850U
	Complete	BOX850UC

134°
SSS

Material: Radel.

Ensure boxes do not touch the walls of the autoclave to avoid damage.



■ Surgical box contents

REF	Description	BOX850UC
SID001M	Lance Drill Ø2.00 mm. Millimeter.	●
OTD00PSX	Initial Pilot Drill Millimeter.	●
OTD10PSX	Pilot Drill P1. Millimeter.	●
OTD20PSX	Pilot Drill P2. Millimeter.	●
OTD30PSX	Pilot Drill P3. Millimeter.	●
OTD33SX	Final surgical drill. F1	●
OTD37SX	Final surgical drill. F2	●
OTD40SX	Final surgical drill. F3	●
OTD43SX	Final surgical drill. F4	●
OTD46SX	Final surgical drill. F5	●
OTD50SX	Final surgical drill. F6	●
CLD34	Crestal surgical drill. Ø4.10 mm.	●
CLD50	Crestal surgical drill. Ø5.10 mm.	●
ZMPD160	Calibrated drill stop. 1. H6 mm.	●
ZMPD170	Calibrated drill stop. 1. H7 mm.	●
ZMPD185	Calibrated drill stop. 1. H8.5 mm.	●
ZMPD110	Calibrated drill stop. 1. H10 mm.	●
ZMPD115	Calibrated drill stop. 1. H11.5 mm.	●
ZMPD113	Calibrated drill stop. 1. H13 mm.	●
ZMPD114	Calibrated drill stop. 1. H14.5 mm.	●
ZMPD260	Calibrated drill stop. 2. H6 mm.	●
ZMPD270	Calibrated drill stop. 2. H7 mm.	●
ZMPD285	Calibrated drill stop. 2. H8.5 mm.	●
ZMPD210	Calibrated drill stop. 2. H10 mm.	●
ZMPD215	Calibrated drill stop. 2. H11.5 mm.	●
ZMPD213	Calibrated drill stop. 2. H13 mm.	●
ZMPD214	Calibrated drill stop. 2. H14.5 mm.	●
MTAPST33	Surgical tap. Ø3.30 mm. Millimeter.	●
MTAPST37	Surgical tap. Ø3.70 mm. Millimeter.	●
MTAPST40	Surgical tap. Ø 4.00 mm. Millimeter.	●
MTAPST42	Surgical tap. Ø 4.30 mm Millimeter.	●
MTAPST46	Surgical tap. Ø4.60 mm Millimeter.	●
MTAPST50	Surgical tap. Ø5.00 mm. Millimeter.	●
DEXT10	Drill extender	●
O1MOHW	ZPlus block key.	●
MUR101	Depth Probe/Paralleling Pin Initial. Millimeter.	●
MUR201	Depth Probe/Paralleling Pin P1. Millimeter.	●
MUR301	Depth Probe/Paralleling Pin P2. Millimeter.	●
MUR401	Depth Probe/Paralleling Pin P3. Millimeter.	●
O1MMIN	ZPlus insertion key. Short.	●
TLMIN	ZPlus insertion key. Long.	●
TSMIN	ZPlus insertion key. Short.	●
MESD	Screwdriver tip. 1.25 mm. Long.	●
SMSD	Surgical screwdriver. 1.25 mm. Short.	●
LMSD	Surgical screwdriver. 1.25 mm. Long.	●
TORK50	Regulable torque wrench	●

Surgical instruments

SURGICAL DRILLS

Lance drill



Platf.	Diameter (Ø)	Length (L)	Reference
	2.00	16.30	SID001M

Millimeter: 6/7/8.5/10/11.5/13/14.5



Initial pilot drill



Platf.	Diameter (Ø)	Length (L)	Reference
	1.80/2.50	17.50	OTD00PSX

Millimeter: 6/7/8.5/10/11.5/13/14.5



Pilot drill



Platf.	Type	Diameter (Ø)	Length (L)	Reference
	Pilot 1	2.90/3.10	17.50	OTD10PSX
	Pilot 2	3.35/3.70	17.50	OTD20PSX
	Pilot 3	4.37/3.90	17.50	OTD30PSX

Millimeter: 6/7/8.5/10/11.5/13/14.5



Final drill



Platf.	Type	Diameter (Ø)	Length (L)	Reference
	Final 1	3.40	6.50	OTD33SX
	Final 2	4.10	6.50	OTD37SX
	Final 3	4.10	6.50	OTD40SX
	Final 4	4.10	6.50	OTD43SX
	Final 5	5.10	6.50	OTD46SX
	Final 6	5.10	6.50	OTD50SX



Crestal surgical drill



Platf.	Diameter (Ø)	Reference
Universal	4.10	CLD34
	5.10	CLD50



STOPS

Calibrated drill stop



Platf.	Type	Length (L) Implant	Reference	
	1	6.00	ZMPD160	
		7.00	ZMPD170	
		8.50	ZMPD185	
		10.00	ZMPD110	
		11.50	ZMPD115	
		13.00	ZMPD113	
		14.50	ZMPD114	
		2	6.00	ZMPD260
			7.00	ZMPD270
			8.50	ZMPD285
			10.00	ZMPD210
			11.50	ZMPD215
			13.00	ZMPD213
			14.50	ZMPD214
Pack *	--	--	KZMPD100	

* Complete pack of 14 calibrated stops.



TAPS

Surgical tap. CA/Manual



Platf.	Diameter (Ø)	Reference
	3.30	MTAPST33
	3.70	MTAPST37
	4.00	MTAPST40
	4.30	MTAPST42
	4.60	MTAPST46
	5.00	MTAPST50

Millimeter: 6/7/8.5/10/11.5/13/14.5



See surgical drilling protocol for more information on using tap.

PROBES

Depth Probe/Paralleling Pin



Platf.	Type	Diameters (Ø1-Ø2)	Length (L)	Reference
	Initial	1.80/2.50	27.00	MUR101
	Pilot 1	2.70/3.00	27.00	MUR201
	Pilot 2	3.05/3.60	27.00	MUR301
	Pilot 3	3.70/4.35	27.00	MUR401

Millimeter: 6/7/8.5/10/11.5/13/14.5



Surgical instruments

INSERTION KEYS

ZPlus insertion key. Ratchet



Platf.	Length (L)	Reference
ZPlus	3.10/Mini	XSMIN *
	5.60/Short	TSMIN
	10.60/Long	TLMIN

● Hexagonal 2.4 mm / ■ Square 4x4 mm



*Ref. XSMIN is NOT included in the surgical box.

ZPlus insertion key CA



Platf.	Length (L)	Reference
ZPlus	15.90	01MMIN*
	23.90	02MMIN *

● Hexagonal 2.4 mm



*Ref. 01MMIN/02MMIN are NOT included in the surgical box.

ZM4 insertion key. Ratchet

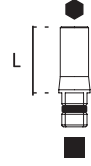

Platf.	Length (L)	Reference
■	15.00	SMEX20*
■	15.00	SMEX34*
■	15.00	SMEX50*

● Hexagonal NP 2.30 mm
 ● Hexagonal RP 2.70 mm
 ● Hexagonal WP 3.00 mm
 ■ Square 4x4 mm



*Ref. SMEX20/SMEX34/SMEX50 are NOT included in the surgical box.

ZM4 insertion key. CA



Platf.	Length (L)	Reference
■	7.50	MMEX20*
■	7.50	MMEX34*
■	7.50	MMEX50*

● Hexagonal NP 2.30 mm
 ● Hexagonal RP 2.70 mm
 ● Hexagonal WP 3.00 mm



*Ref. MMEX20/MMEX34/MMEX50 are NOT included in the surgical box.

Drill extender

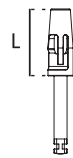

Platf.	Length (L)	Reference
Universal	12.00	DEXT10



SCREWDRIVERS

Screwdriver tip. CA



Platf.	Length (L)	Reference
Universal	20.00/Short	MESD01
	25.00/Long	MESD

● Hexagonal 1.25 mm



Surgical screwdriver. Manual



Platf.	Length (L)	Reference
Universal	2.80/Mini	XSMSD
	9.50/Short	SMSD
	14.50/Long	LMSD
	27.00/Extralong	XLMSD

● Hexagonal 1.25 mm



ZPlus block key

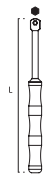

Platf.	Length (L)	Reference
ZPlus	90.00	01MOHW

● Hexagonal 2.4 mm



RATCHET

Regulable torque wrench



Platf.	Length (L)	Reference
Universal	86.80	TORK50

■ Square 4x4 mm



Surgical instruments

Additional kit

ADAPTORS

Ratchet extension



Platf.	Length (L)	Reference
Universal	7.20	LAEX

■ Square 4x4 mm



NOT included in the surgical box.

Ratchet to CA adaptor



Platf.	Length (L)	Reference
Universal	7.20	MAEX

■ Square 4x4 mm



NOT included in the surgical box.

IMPLANT MOUNT

Extra long mount



Platf.	Length (L)	Reference
■ Yellow	10.10/ExtraLong	MOUNT20
■ Blue	10.10/ExtraLong	MOUNT34

● Hexagonal NP 2.30 mm

● Hexagonal RP 2.70 mm

■ Square 4x4 mm



NOT included in the surgical box.

LABORATORY TEST KIT

Laboratory test kit

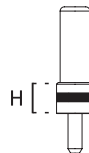

Platf.	Height (H)	Reference
■ Yellow	3.65	EXLAB20
■ Blue	3.65	EXLAB34



This product does not supersede the need for careful planning of each clinical case.

NOT included in the surgical box.

RADIOGRAPHIC TEMPLATE

ZM4 radiographic template

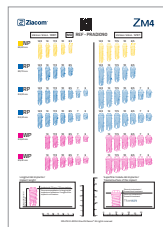

Platf.	Model	Reference
■ Yellow ■ Blue ■ Pink	ZM4	PRADIO90

Scales 1:1 and 1:1.25

Material: transparent acetate. Non-sterilisable component

See the literature available at www.ziacom.com/biblioteca



Prosthetic instruments

Prosthetic box

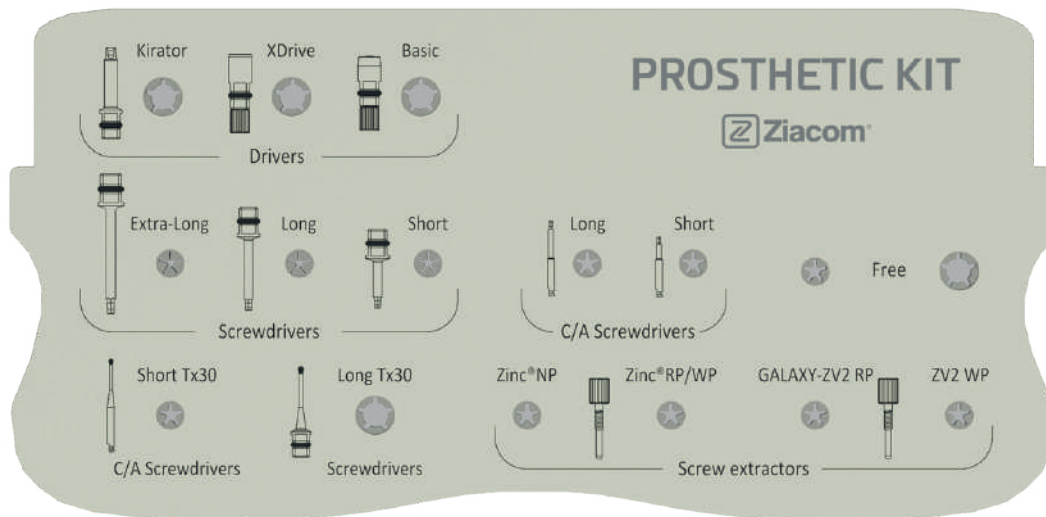

■ Contents of prosthetic boxes available

Contents	Reference
Empty	BOXPN
Basic	BOXPSN
Complete	BOXPCN



Material: Radel.

Ensure boxes do not touch the walls of the autoclave to avoid damage.



■ Contents of prosthetic boxes

REF	Description	BOXPSN	BOXPCN
LOSD01	Kirator insertion key.	●	●
MABA100	Basic insertion key. Short.	●	●
MABA200	XDrive insertion key. Short.	●	●
MADW10	Screwdriver handle. 4x4.	●	●
SMSD1	Screwdriver tip. 1.25 mm. Short.	●	●
LMSD1	Screwdriver tip. 1.25 mm. Long.	●	●
XLMSD1	Screwdriver tip. 1.25 mm. Extra long.		●
MESD	Screwdriver tip. 1.25 mm. Long.	●	●
MESD01	Screwdriver tip. 1.25 mm. Short.	●	●
MESD1TX	Tx30 screwdriver tip. Long.	●	●
LMSD1TX	Tx30 screwdriver tip. Long.	●	●
EDSZ20 *	ZPlus screw extractor. NP		●
EDSZ34 *	ZPlus screw extractor. RP/WP.		●
EDSG34 *	Abutment extractor screw. RP		●
EDSG50 *	Abutment extractor screw. WP		●
TORK50	Regulable torque wrench	●	●

*Product not included in the ZM4 system.

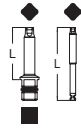
KEYS
Kirator insertion key

System	Length (L)	Reference
Kirator	13.60/Ratchet/Manual 20.00/CA	LOSD01 LOSD02 *

◆ Square 2.11 mm / ■ Square 4x4 mm

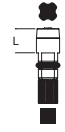

*Ref. LOSD02 is NOT included in the prosthetic box.

Basic insertion key. Ratchet

System	Length (L)	Reference
Basic	5.00/Short 13.00/Long	MABA100 MABA110 *

◆ Basic / ■ Square 4x4 mm

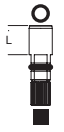

*Ref. MABA110 is NOT included in the prosthetic box.

XDrive insertion key Ratchet

System	Length (L)	Reference
XDrive	6.00/Short 13.00/Long	MABA200 MABA210*

○ XDrive / ■ Square 4x4 mm



*Ref. MABA210 is NOT included in the prosthetic box.

Nature insertion key. Ratchet

System	Length (L)	Reference
Nature	5.00/Short 15.00/Long	MANA100* MANA110*

◆ Nature / ■ Square 4x4 mm

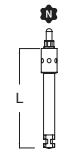

*Ref. MANA100/MANA110 are NOT included in the prosthetic box.

Nature insertion key. CA

System	Length (L)	Reference
Nature	20.50	MANA120*

◆ Nature

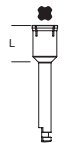

*Ref. MABA210 is NOT included in the prosthetic box.

Basic insertion key. CA

System	Length (L)	Reference
Basic	7.00	MABA120*

◆ Basic



*Ref. MABA210 is NOT included in the prosthetic box.

XDrive insertion key CA

System	Length (L)	Reference
XDrive	7.00	MABA220*

○ XDrive



*Ref. MABA220 is NOT included in the prosthetics box.

Prosthetic instruments

SCREWDRIVERS

Screwdriver adapter handle

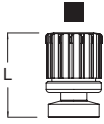



Platf.	Length (L)	Reference
Universal	12.90	MADW10

■ Square 4x4 mm

Stainless Steel

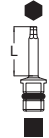
Screwdriver tip. Ratchet





Platf.	Length (L)	Reference
Universal	9.50/Short	SMSD1
	14.50/Long	LMSD1
	27.00/ExtraLong	XLMSD1

■ Square 4x4 mm

1,25mm Stainless Steel



Screwdriver tip. CA

Platf.	Length (L)	Reference
Universal	20.00/Short	MESD01
	25.00/Long	MESD

1,25mm Stainless Steel

Tx30 screwdriver tip. CA



System	Length (L)	Reference
Tx30	26.00/Short	MESD01TX *
	32.00/Long	MESD1TX

Stainless Steel

Do not exceed 30 Ncm as it could cause severe damage to the screwdriver and screw

* Ref. MESD01TX is NOT included in the prosthetics box.

Tx30 screwdriver tip. Ratchet

System	Length (L)	Reference
Tx30	12.00/Short	SMSD1TX *
	18.00/Long	LMSD1TX



■ Square 4x4 mm

Stainless Steel

Do not exceed 30 Ncm as it could cause severe damage to the screwdriver and screw

*Ref. SMSD1TX is NOT included in the prosthetic box.

Tx30 prosthetic screwdriver. Manual

System	Length (L)	Reference
Tx30	12.00/Short	SMSD1TX *
	18.00/Long	LMSD1TX *
	27.00/ExtraLong	XLMSD1TX *



Stainless Steel

Do not exceed 30 Ncm as it could cause severe damage to the screwdriver and screw

*Ref. SMSD1TX/LMSD1TX/XLMSD1TX are NOT included in the prosthetics box.

EXTRACTOR SCREW

ZPlus screw extractor





Platf.	Length (L)	Reference
● Yellow	25.00	EDSZ20 *
● Blue	23.70	EDSZ34 *

Anodised ■ NP ■ RP/WP

1,25mm M1,60 M1,80 Grade 5 EU Titanium

Galaxy/ZV2 abutment screw extractor

Platf.	Length (L)	Reference
■ Yellow	25.00	EDSG34 *
■ Pink	26.80	EDSG50 *

Anodised ■ RP ■ WP

1,25mm M1,60 M2,00 Grade 5 EU Titanium

*Product not included in the ZM4 system.

RATCHET

Regulable torque wrench

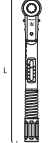
Platf.	Length (L)	Reference
Universal	86.80	TORK50

■ Square 4x4 mm

Stainless Steel

Complementary instruments

CA to ratchet adaptor



Platf.	Length (L)	Reference
Universal	12.00	MC10Z

■ Square 4x4 mm



NOT included in the prosthetic box.

Extractor + Retainer inserter handle

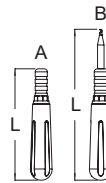

Platf.	A Length (L)	B Length (L)	Reference
Kirator	81.50	110.40	MBEI3610
ZM-Equator			



NOT included in the prosthetic box.

Retention inserter

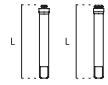

Platf.	Length (L)	Reference
Kirator	32.00	MBEI3602
ZM-Equator	32.00	MBEI3603



Kirator / ZM-Equator plastic cap insertion tool.
NOT included in the prosthetic box.

Retentive joints instruments



Platf.	Dimensions	Reference
Universal	2x1	RREI0030

Pack of 10 units.

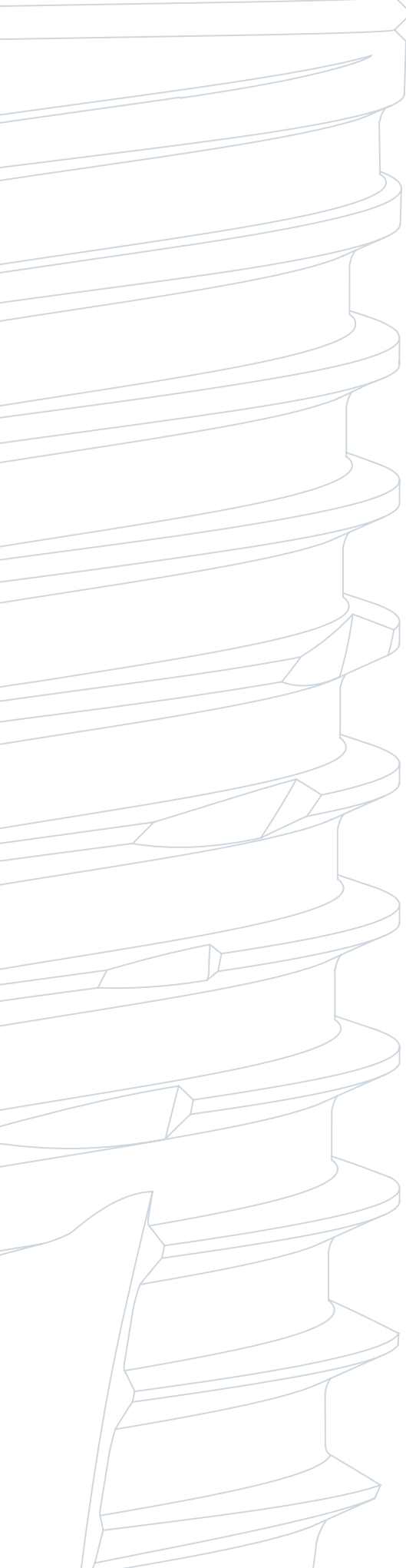

ZM4

Surgical
protocols

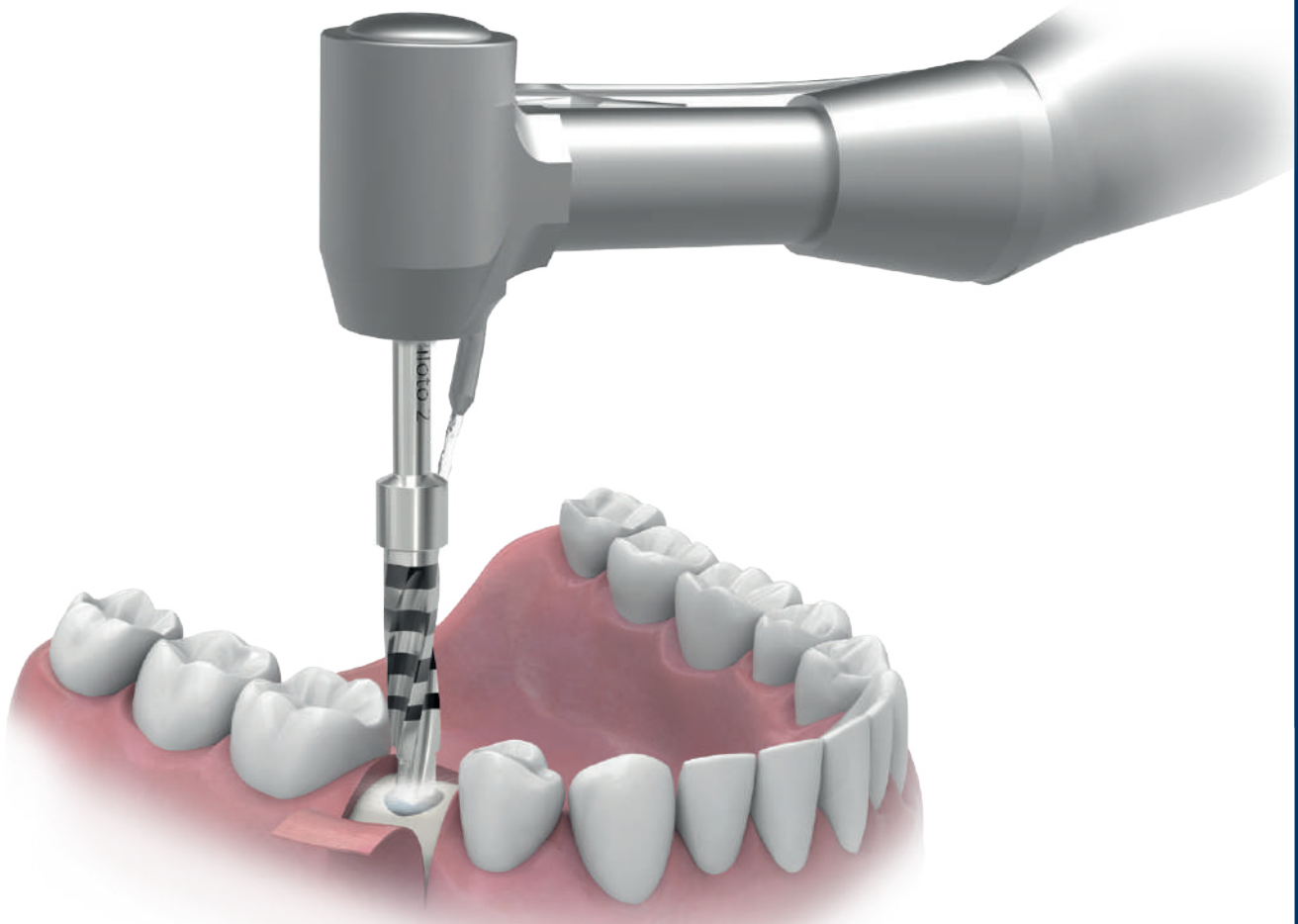

Surgical protocol

Features of the ZM4 drilling system

■ Ziacom® drill system

Ziacom® implant system drills are made from stainless steel. A laser marking on the bur's shank identifies its inner and outer diameters and its length, while the horizontal laser marked bands on the active section corresponds to the different lengths of the implants (millimeter drills). The drill tip is 0.5 mm long and this is not included in the different laser-marked lengths.

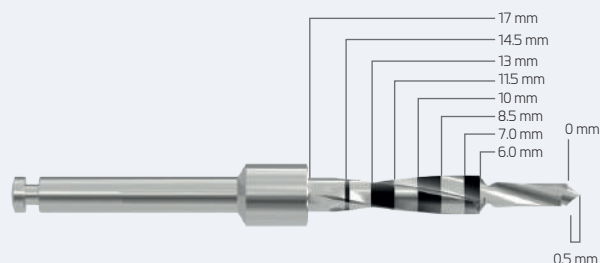

■ Ziacom® Final Drills

Its use is essential and mandatory in order to achieve an ideal finish of the prepared implant bed for smooth, safe and precision insertion. In this way, overtorquing of the implant can be avoided while it is placed into its final position.

■ FINAL DRILL STOP

A stop, consisting of three blades (see red areas marked on image) has been incorporated into the design of the final drills, between the active area and the shank, to limit the penetration of the drill.

IMPORTANT

Take care not to drill beyond the stop, as this modifies the coronal anatomy of the surgical site.

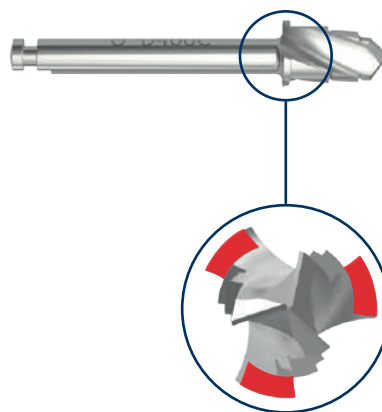

■ ZIACOM® DRILLS EFFICIENCY GUARANTEE

Surgical drills for Ziacom® ZM4 implants (**cortical drills, lance drill, initial drill, pilot drills and final drills**) have a **lifetime of up to 60 uses**. It is advisable to monitor the cutting condition at all times, especially when reaching around 41 to 50 uses, since after 50 uses it is necessary to consider changing the drills before reaching 60 uses.

Bear in mind that, depending on the size of the implant, bone density and your surgical protocol, not all of the various drills will be used equally – it is recommended that you monitor the number of uses for each instrument.

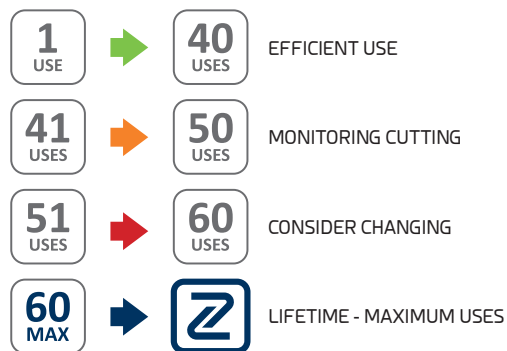

■ Ziacom® taps

Thread taps are available for contra-angle handpieces. The laser marking on the tap's shank identifies its diameter, while the horizontal laser marked bands on the active section corresponds to the different lengths.

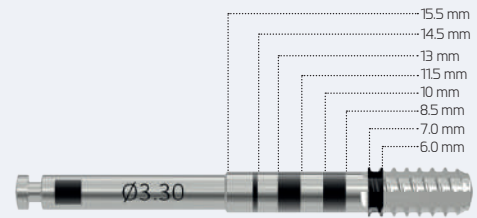

■ Probe

Check the depth of the surgical site, especially when not using drill stops. To check the surgical bed axis, the paralleling pins are available in different diameters according to the drilling sequence.

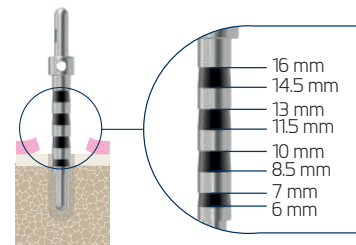

■ Short and long insertion keys for ratchets and contra-angle handpieces

The insertion keys for contra-angle handpieces or ratchets have been designed for transporting implants from their No-Mount vial to the surgical site ready for insertion.



■ Drill stops

These are a surgical accessory that attach to drills and facilitate the work as they determine the depth of the osteotomy, providing extra assurance when preparing the surgical site.



Surgical protocol

Features of the ZM4 drilling system

Internal view of the ZM4 surgical box

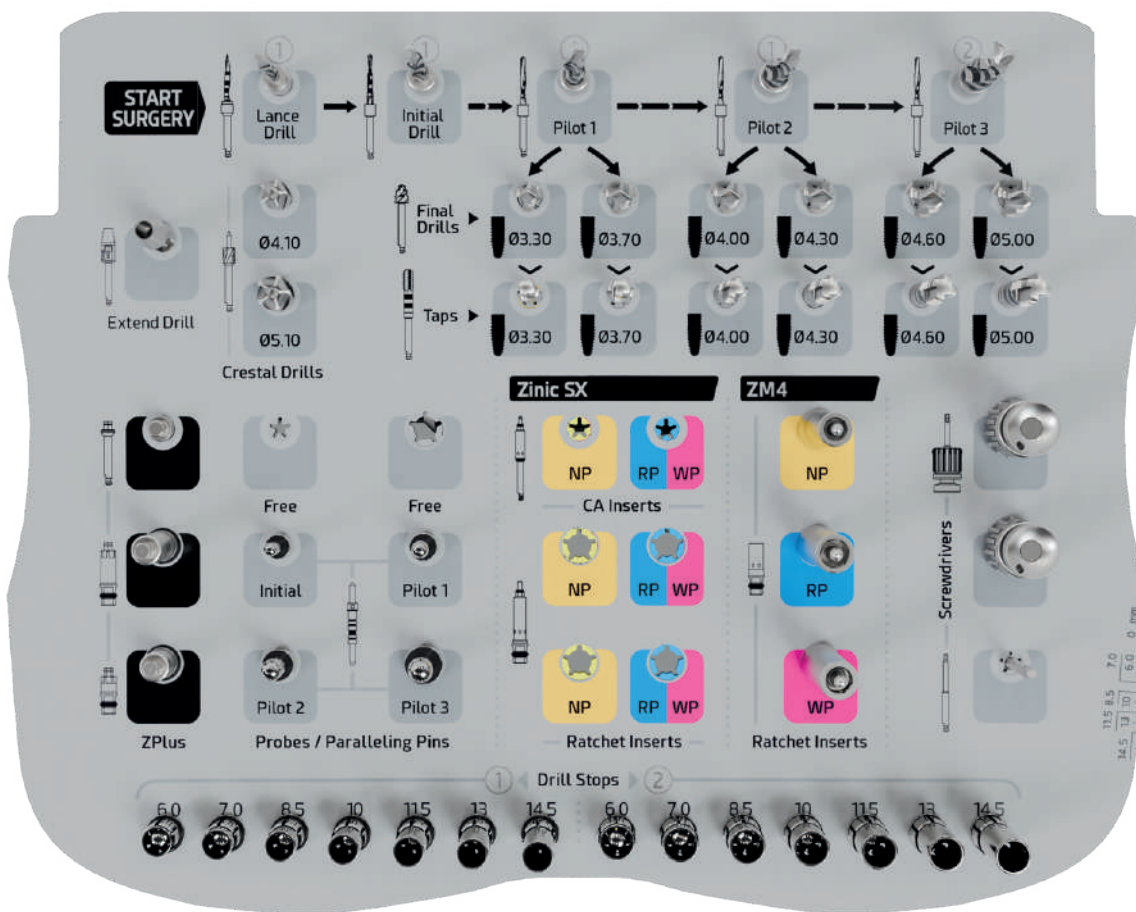

Recommendations on the maximum implant insertion torque



The recommended insertion torque ranges between **35** and **50 Ncm** on a case-by-case basis.

To avoid deforming the insertion key and/or implant connection, insertions performed with a contra-angle handpiece (CA) must respect the recommended maximum rpm (25 rpm) and maximum torque (50 Ncm).

If the implant cannot be fully inserted using the recommended maximum torque, withdraw the implant, repeat the drilling and then re-insert it.

Check the final insertion torque with the adjustable dynamometric ratchet Ref. TORK50 or a contra-angle handpiece.

Exceeding the maximum torque (50 Ncm) when inserting the implant may result in:

- Irreversible deformations in the implant's internal connection.
- Irreversible deformations in the implant insertion instruments.
- Difficulty or impossibility in dismantling the instrument/implant assembly.

ZM4 implant

It is important to note that the drilling protocol for ZM4 implants using stepped drill bits varies significantly based on the implant diameter and the type of bone at the surgical site, and therefore it is important to pay special attention to these two aspects.

ZM4

- **EXAMPLE:**
- ZM4 implant
- Ø4.00x11.50mm
- **RP** (Ø 4.00 mm)
- Platform Ø 3.50mm

High-density drilling protocol steps (D1 - D2*)

PRELIMINARY STEP | Opening the gum

Make an incision and raise the flap.

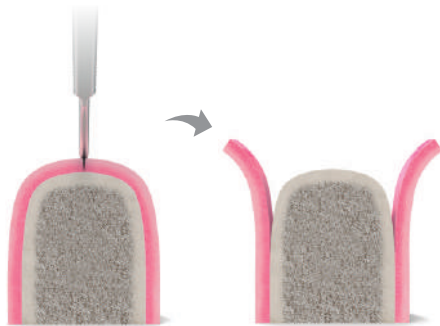

STEP 1 | Lance drill



Start the implant site drilling sequence using the Lance Drill Ref. SID001M. Be aware of the laser marking on the drill to indicate the length, or use drill stop Ref. ZMPD115. Control the direction and angle of drilling by applying intermittent pressure vertically, taking care not to exert too much pressure on the bone. If necessary, use drill extender Ref. DEXT10.



STEP 2 | Initial drill



Continue the drilling sequence using Initial Drill Ref. OTD00PSX until the total length of the chosen implant is reached. Be aware of the laser marking on the drill that indicates the length, or use the drill stop Ref. ZMPD115. Monitor the direction and inclination of the drilling, exerting pressure intermittently, always in a vertical direction, taking care not to generate excessive pressure on the bone. If necessary, use drill extender Ref. DEXT10.



STEP 3 | Depth Probe/Paralleling Pin Initial



Check the depth of the surgical site and the insertion axis by inserting the Depth Probe/Paralleling Pin Initial Ref. MUR101. Repeat this step as many times as necessary during the surgery.

Surgical protocol

STEP 4 | Pilot drill 1



Continue the drilling sequence using Pilot Drill 1 Ref. OTD10PSX, until the full length of the chosen implant is reached. Be aware of the laser marking on the drill to indicate the length, or use drill stop Ref. ZMPD115. Control the direction and angle of drilling by applying intermittent pressure vertically, taking care not to exert too much pressure on the bone. If necessary, use drill extender Ref. DEXT10.



NOTE

Once this step has been completed, to fit an implant with diameter:

- $\varnothing 3.30$ mm > Final drill 1 Ref. OTD33SX + Tap MTAPST33
- $\varnothing 3.60$ mm > Final drill 2 Ref. OTD37SX + Tap MTAPST37

STEP 5 | Depth Probe/Paralleling Pin Pilot 1



Check the depth of the surgical site and the insertion axis by inserting the Depth Probe/Paralleling Pin Pilot 1 Ref. MUR201. Repeat this step as many times as necessary during the surgery.

STEP 6 | Pilot drill 2



Continue the drilling sequence using Pilot Drill 2 Ref. OTD20PSX, until the full length of the chosen implant is reached. Be aware of the laser marking on the drill to indicate the length, or use drill stop Ref. ZMPD115. Control the direction and angle of drilling by applying intermittent pressure vertically, taking care not to exert too much pressure on the bone. If necessary, use drill extender Ref. DEXT10.



NOTE

Once this step has been completed, to fit an implant with diameter:

- $\varnothing 4.00$ mm > Final drill 3 Ref. OTD40SX + Tap MTAPST40
- $\varnothing 3.30$ mm > Final drill 4 Ref. OTD43SX + Tap MTAPST42

STEP 7 | Depth Probe/Paralleling Pin Pilot 2



Check the depth of the surgical site and the insertion axis by inserting the Depth Probe/Paralleling Pin Pilot 2 Ref. MUR301MT. Repeat this step as many times as necessary during the surgery.

STEP 8 | Final Drill 3



Continue the drilling sequence using Final Drill 3 Ref. OTD40SX, up to the length corresponding to the cortical bone thickness, according to individual clinical case. Control the direction and angle of drilling by applying intermittent pressure vertically, taking care not to exert too much pressure on the bone. If necessary, use drill extender Ref. DEXT10.



STEP 9 | Surgical tap $\varnothing 4.00$



Place the $\varnothing 4.00$ mm surgical tap, Ref. MTAPST40 in the surgical site. Apply firm pressure and start to turn slowly. Once threads engage, continue to screw the tap in without pressure to the planned depth. If excessive resistance is met, turn 90° anti-clockwise after each complete turn. To remove the tap, turn it anti-clockwise. While using the tap, it is recommended that you pass it along the entire length of the implant.



■ Important notes: Type D2* Bone Density

In the case of type D2 bone density, the surgical drilling protocol indicated for type D1 bone density should be followed, leaving out the use of the Surgical Tap on any of the implant diameters. Nevertheless, it is up to the discretion of the professional to decide on full or partial use the Surgical Tap, based on their clinical experience and the identification of the density of the existing bone at the site. This is particularly relevant in cases where the bone density varies significantly along the length of the osteotomy for the implant.



Surgical protocol

Low-density drilling protocol steps (D3 - D4**)

PRELIMINARY STEP | Opening the gum

Make an incision and raise the flap.

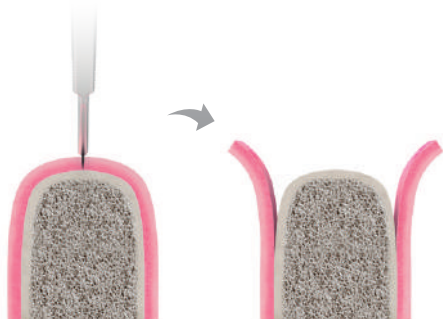

STEP 1 | Lance Drill

Start the implant site drilling sequence using the Lance Drill Ref. SID001M. Be aware of the laser marking on the drill to indicate the length, or use drill stop Ref. ZMPD115. Control the direction and angle of drilling by applying intermittent pressure vertically, taking care not to exert too much pressure on the bone. If necessary, use drill extender Ref. DEXT10.



STEP 2 | Initial drill

Continue the drilling sequence using Initial Drill Ref. OTD00PSX until the total length of the chosen implant is reached. Be aware of the laser marking on the drill that indicates the length, or use the drill stop Ref. ZMPD115. Monitor the direction and inclination of the drilling, exerting pressure intermittently, always in a vertical direction, taking care not to generate excessive pressure on the bone. If necessary, use drill extender Ref. DEXT10.



NOTE

Once this step has been completed, to fit an implant with diameter:

- Ø3.30mm > Final Drill 1 Ref. OTD33SX
- Ø3.60mm > Final Drill 2 Ref. OTD37SX

STEP 3 | Depth Probe/Paralleling Pin Initial

Check the depth of the surgical site and the insertion axis by inserting the Depth Probe/Paralleling Pin Initial Ref. MUR101. Repeat this step as many times as necessary during the surgery.



STEP 4 | Pilot drill 1

Continue the drilling sequence using Pilot Drill 1 Ref. OTD10PSX, until the full length of the chosen implant is reached. Be aware of the laser marking on the drill to indicate the length, or use drill stop Ref. ZMPD115. Control the direction and angle of drilling by applying intermittent pressure vertically, taking care not to exert too much pressure on the bone. If necessary, use drill extender Ref. DEXT10.



NOTE

Once this step has been completed, to fit an implant with diameter:

- Ø4.00 mm > Final Drill 3 Ref. OTD40SX
- Ø4.40 mm > Final Drill 4 Ref. OTD43SX

STEP 5 | Depth Probe/Paralleling Pin Pilot 1

Check the depth of the surgical site and the insertion axis by inserting the Depth Probe/Paralleling Pin Pilot 1 Ref. MUR201. Repeat this step as many times as necessary during the surgery.



STEP 7 | Final Drill 3



Continue the drilling sequence using Final Drill 3 Ref. OTD40SX, up to the length corresponding to the cortical bone thickness, according to individual clinical case. Control the direction and angle of drilling by applying intermittent pressure vertically, taking care not to exert too much pressure on the bone. If necessary, use drill extender Ref. DEXT10.



■ Important notes: Type D4** Bone Density

In the case of type D4 bone density, the surgical drilling protocol indicated for type D3 bone density should be followed, leaving out the use of the last Final Drill for each of the implant diameters. Nevertheless, it is up to the discretion of the professional to decide to use the last Final Drill fully or partially, based on their clinical experience and the identification of the density of the existing bone at the site. This is particularly relevant in cases where the bone density varies significantly along the length of the osteotomy for the implant.

Surgical protocol

Implant placement with ZPlus Mount | Titansure

ZPlus Mount

Surface treatment

Titansure

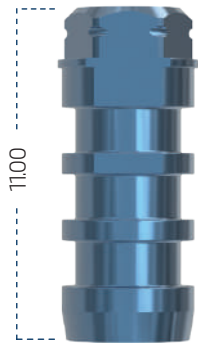

STEP 1 | Unpacking the implant

- 1.1 Press the word "PRESS" and tear open the box.
- 1.2 Remove the top of the carton and take out the blister pack.
- 1.3 Carefully remove the seal from the blister pack.
- 1.4 Turn the vial containing the implant out onto a sterile cloth in the operating area.
- 1.5 Remember to remove the label from the implant and to stick it onto the patient's implant card and clinical records to ensure that the product is traceable.

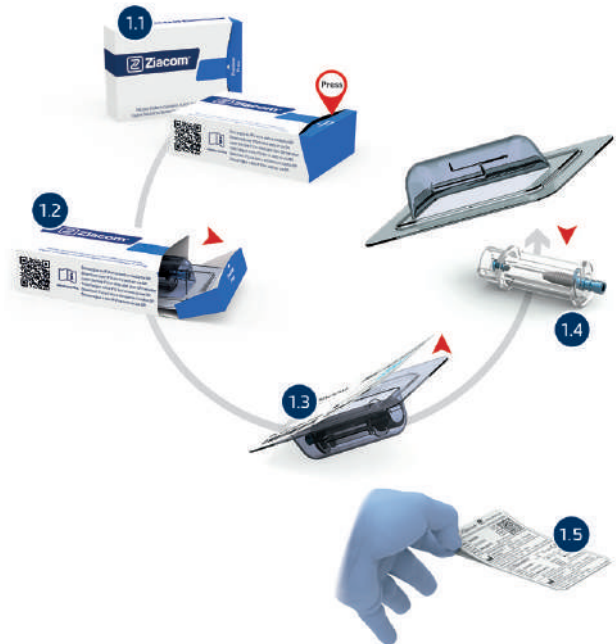

STEP 2 | Choosing the right insertion instrument

Based on the specific clinical situation and access to the surgical site, one of three different instruments can be selected to insert the implant:

- Contra-angle:** use the ZPlus insertion key. CA insertion key of the desired length Ref.s 01MMIN / 02MMIN and insert it into the contra-angle.
- Torque wrench Ref. TORK50:** use the ZPlus insertion key. Ratchet/Manual insertion key of the desired length Ref. XSMIN / TSMIN / TLMIN and insert it into the ratchet set to function "IN", which is identified with an arrow.
- Screwdriver handle 4x4 Ref. MADW10:** use the ZPlus insertion key. Ratchet/Manual insertion key of the desired length Ref. XSMIN / TSMIN / TLMIN and insert it into the screwdriver handle.

STEP 3 | Removing the implant from its vial

Hold the vial containing the implant in one hand and insert the selected ZPlus insertion key with the other hand. Remove the implant-mount assembly by lifting it vertically out of the vial.

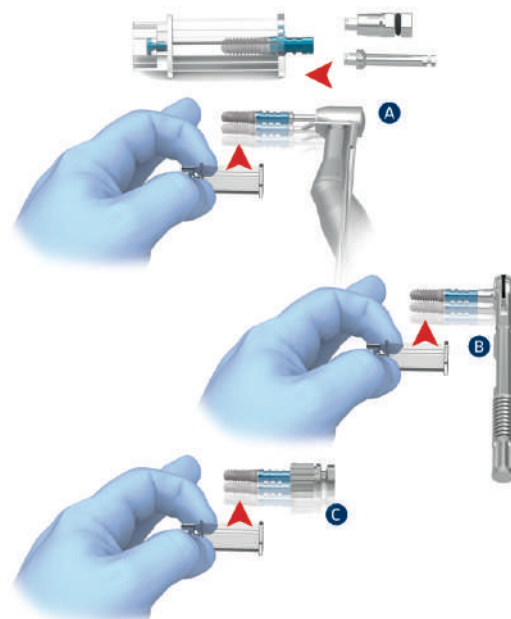

ZM4 implant insertion with ZPlus Mount

STEP 4 | Inserting the implant

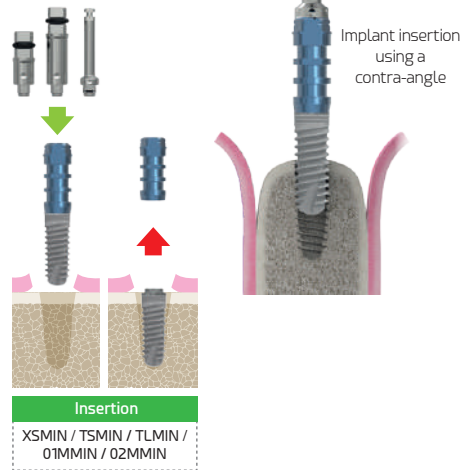

Insert the implant into the surgical site, controlling both the direction and angle of the implant. When inserting the implant with a contra-angle, use a maximum speed of 25 rpm. The recommended insertion torque ranges from 35 to 50 Ncm, according to each case, and is not limited to a single torque.

If resistance is met during insertion, turn the implant slightly anti-clockwise and then continue to insert after waiting a few seconds. Repeat this process as many times as necessary.

The Ziacom® surgical protocol establishes crestal positioning of the implant platform.

The ZPlus has 3 flat sides. After inserting the implant, make sure that one of these flat sides faces the vestibular direction.

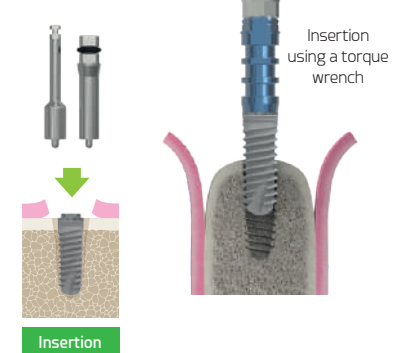

Use direct-to-implant insertion keys, Ref. **SMEX20/SMEX34/SMEX50** for Torque Wrench/Manual and **MMEX20/MEX34/MMEX50** for CA, to adjust the final position of the implant.

STEP 5A | Extracting the ZPlus Mount

Lock the ZPlus mount using locking key Ref. **01MOHW** and remove the screw using manual surgical screwdriver Ref. **SMSD / LMSD**. After removing the screw, remove the ZPlus by hand.

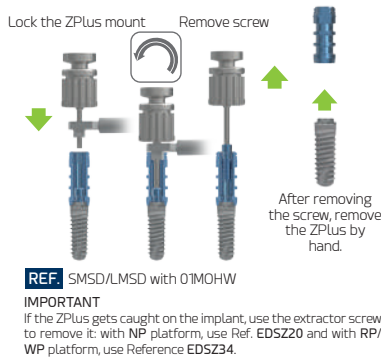

STEP 5B | Extracting the ZPlus Mount

In order to prevent the ZPlus mount from warping or cold welding with the implant, the point of insertion at which the mount should be extracted will depend on the type of bone.

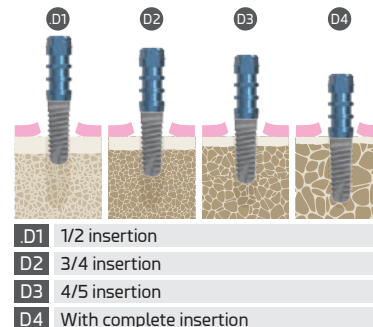

IMPORTANT
The maximum insertion torque for the dental implants is **50 Ncm**. Exceeding the maximum insertion torque for the implants may cause severe damage to the dental implant, its connection, the Mount and the clinical screw included. Check the specifications in the surgical protocol for removal of the Mount, according to the type of implant connection and the bone type.

STEP 6 | Crestal placement of the implant

The Ziacom® ZM4 implant platform should be placed at bone ridge level.

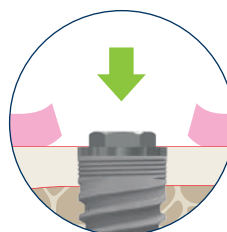

RECOMMENDED
ridge position

Surgical protocol

■ Soft tissue conditioning

STEP 1 | Placing the cover screw

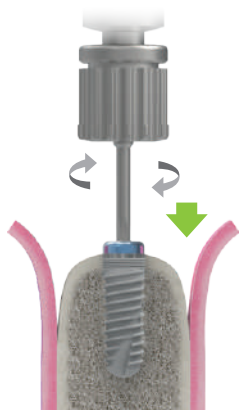

Remove the cover screw anti-clockwise using manual surgical screwdriver Ref. SMSD or LMSD. Move the cover screw towards the implant while taking care not to drop it and cause its accidental ingestion. Insert the screw into the implant until it locks, applying manual torque in a clockwise direction. Placement of the cover screw during the first surgical phase requires that, after the osseointegration period, the second surgical phase should be performed or the implant should be exposed to fit the chosen abutment.

Based on each individual case, you can choose not to place a cover screw but instead to directly attach a healing abutment.



STEP 2 | Closing the soft tissue

Close and suture the soft tissue, carefully lining up the flaps.



STEP 3 | Exposing and extracting the cover screw



Locate the implant and make an incision to expose the cover screw or use tissue punch Ref. MPU34 on the soft tissue. Remove the screw using manual surgical screwdriver Ref. SMSD or LMSD.



STEP 4 | Placing the healing abutment

Insert the chosen healing abutment using manual surgical screwdriver Ref. SMSD or LMSD.

The choice of healing abutment will depend on each individual case. It should match the implant platform and also the height of the gingival tissue in order to prevent occlusion of the abutment. If the abutment is too tall, it may subject the implant to premature loading, compromising the osseointegration process.

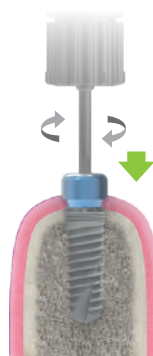

■ Bone types

Misch classification (1988)



TYPE D1 BONE

- Dense cortical and dense trabecular bone.
- > 1250 HU



TYPE D2 BONE

- Porous cortical and dense trabecular bone.
- 850 - 1250 HU



TYPE D3 BONE

- Porous cortical and fine trabecular bone.
- 350 - 850 HU



TYPE D4 BONE

- Thin crestal cortical and fine trabecular bone.
- 150 - 350 HU

HU = Hounsfield Units

IMPORTANT

In order to simplify the surgical drilling protocols, we have created quick drilling guides, in which the criteria for bone types are amalgamated, with D1-D2 treated as "High-Density" bone, and D3-D4 bone types as "Low-Density" bone.

■ Handling of cover screw

Place the cover screw in the screwdriver. Move the cover screw towards the implant while taking care not to drop it and cause its accidental ingestion. Insert it into the implant applying manual torque in a clockwise direction.

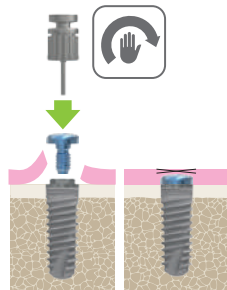

■ Considerations for temporisation and immediate loading

Immediate temporisation and immediate loading are procedures that involve the placement of the prosthesis within 72 hours after implant surgery. The fundamental difference between these procedures is whether or not the prosthesis will have a functional load.

Adequate primary stability of the implant at the time of insertion is crucial to consider placing a provisional or immediately loaded prosthesis. This stability can be objectively measured by the insertion torque, which must be equal to or greater than 40-45 Ncm or by analysing the resonance frequency (ISQ value), which should be greater than or equal to 70.

■ IMMEDIATE TEMPORISATION

Immediate temporisation involves thorough monitoring of occlusion, both in central (closed) position, and during lateral or dynamic movements that occur during mastication. By freeing the provisional from any contact in these situations, the transfer of forces to the implant is prevented.

The main objectives of immediate temporisation are:

- Immediate closure of edentulous spaces in aesthetic areas.
- Guided regeneration of the gingival emergence profile due to the presence of the provisional crown or bridge.

■ IMMEDIATE LOADING

The principle of immediate loading involves the controlled transfer of contact from the moment of placement of the restoration while the restoration is in occlusion; therefore we distinguish between:

- Progressive immediate loading, using an acrylic provisional restoration as the initial restoration (released in dynamic occlusion).
- Definitive immediate loading, with rigid material and active occlusion from day one.

Both processes involve risks to the success of the osseointegration of the implant, so it is up to the practitioner, based on clinical experience and the case in question, whether or not to place an immediate provisional restoration and/or immediate loading.

Restorations using transepithelials

■ Transepithelial abutments

- Allows the peri-implant tissue to form from the initial 8 weeks.
- One abutment-one time, allows gingival adhesion to its surface as repeated detachments are not necessary.
- Avoids bone and soft tissue loss as there is no mechanical rupture of the peri-implant interface.
- The prosthetic working area is above the gingival level, making the soft tissue adhesive behaviour more predictable, maintaining a good seal.
- Less formation of micro-gaps at the implant-prosthesis junction.
- Increased crestal bone preservation.
- Prosthetic try-ins and definitive placement without anaesthesia.
- If the recommended torques are exceeded, the screw suffers the fracture at transepithelial level and not inside the implant.

■ Abutment heights



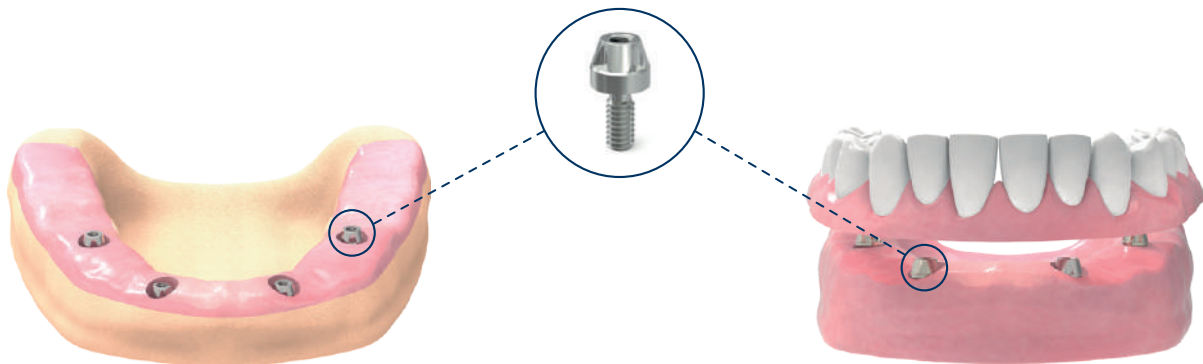

- Greater abutment height means more marginal bone is preserved in cement-retained prostheses.
- Higher abutments ($\geq 2\text{mm}$) provide better soft tissue adaptation.
- Short abutments ($< 2\text{ mm}$) can compromise the soft tissues, resulting in more crestal bone loss.
- Marginal bone loss will differ depending on the clinical decision on the abutment height. Generally, prosthetic abutments $\geq 2\text{mm}$ will lead to better preservation of crestal bone.



Simplified surgical protocol

These surgical guides have been designed with a simplified surgical protocol to perform simple and efficient drilling of the surgical site.

ZPlus - Drilling Protocol

 Rotation
  Irrigation required
  Drill diameter
  Torque
 Detailed speeds are recommended

ZM4 Ø3.30 (Example of implant bed preparation with ZM4 implant Ø3.30x115)

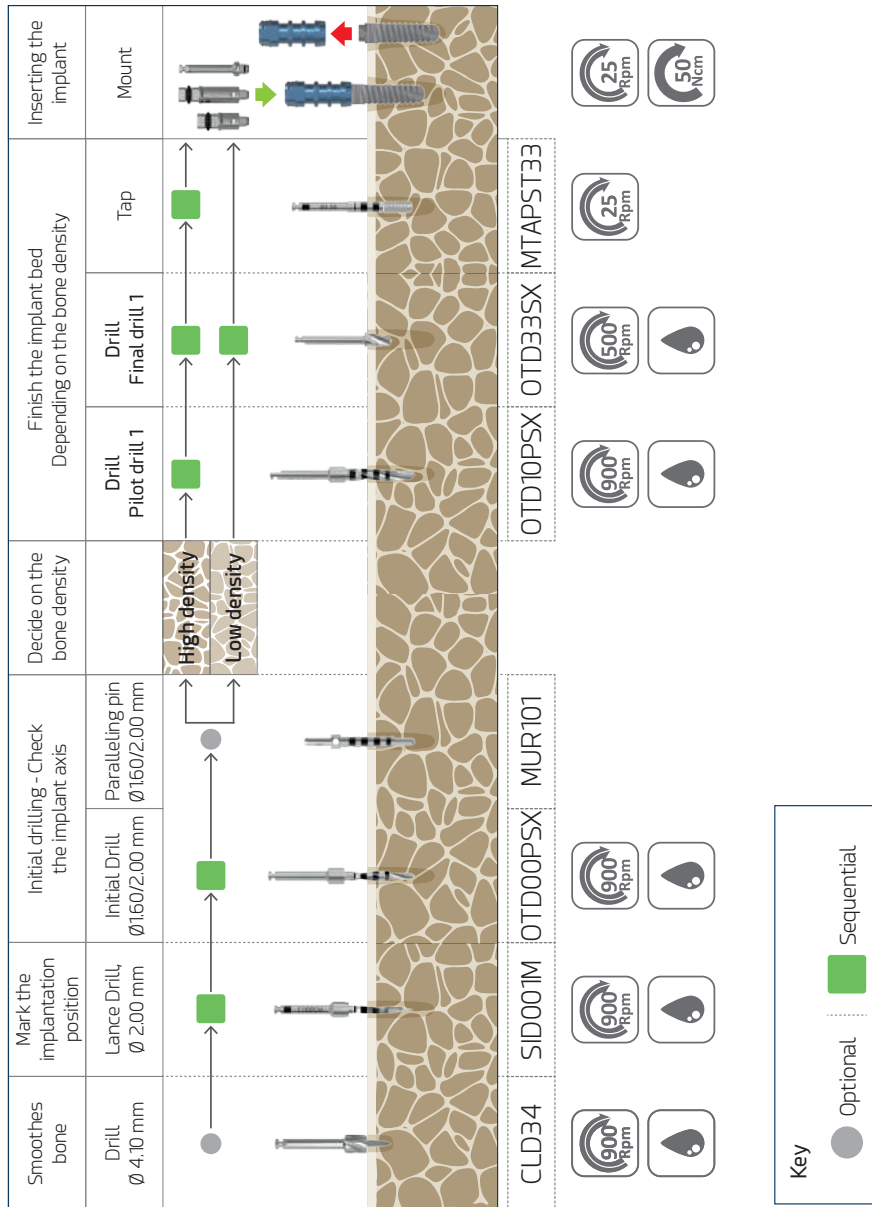

Simplified surgical protocol

ZM4 Ø3.70 (Example of implant bed preparation with ZM4 implant Ø3.70x115)

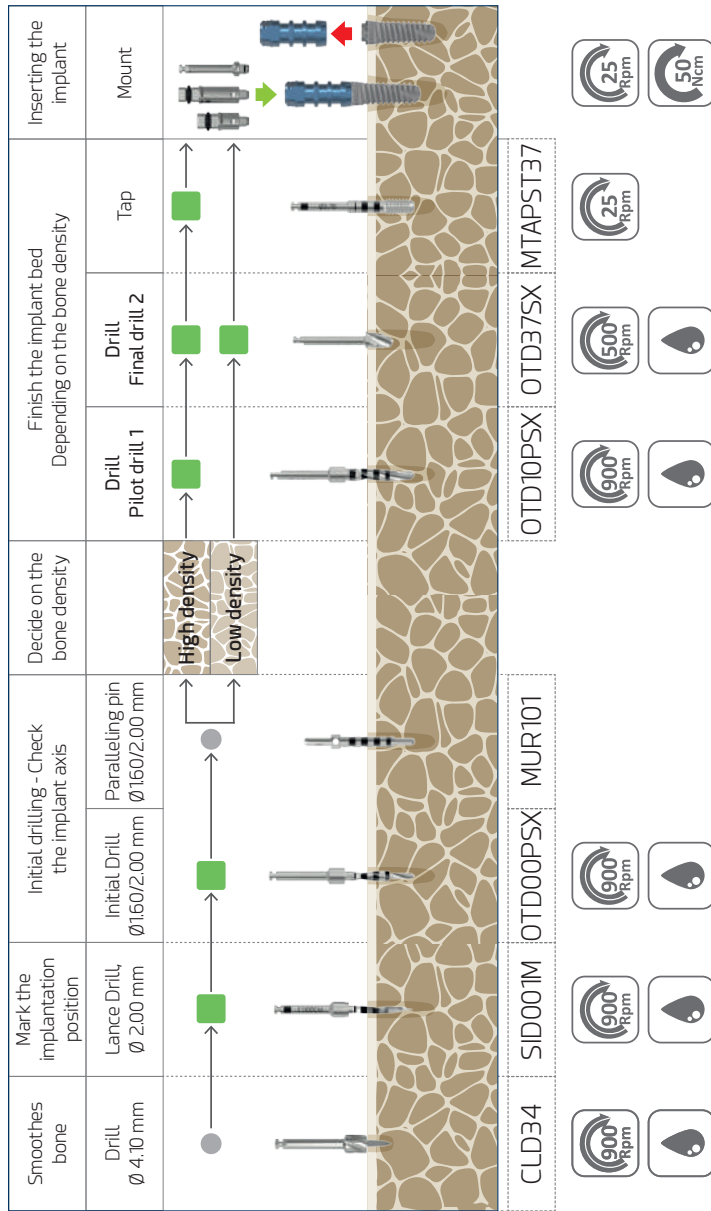

Key

- Optional
- Sequential

ZM4 Ø4.00

(Example of implant bed preparation with ZM4 implant Ø4.00x115)

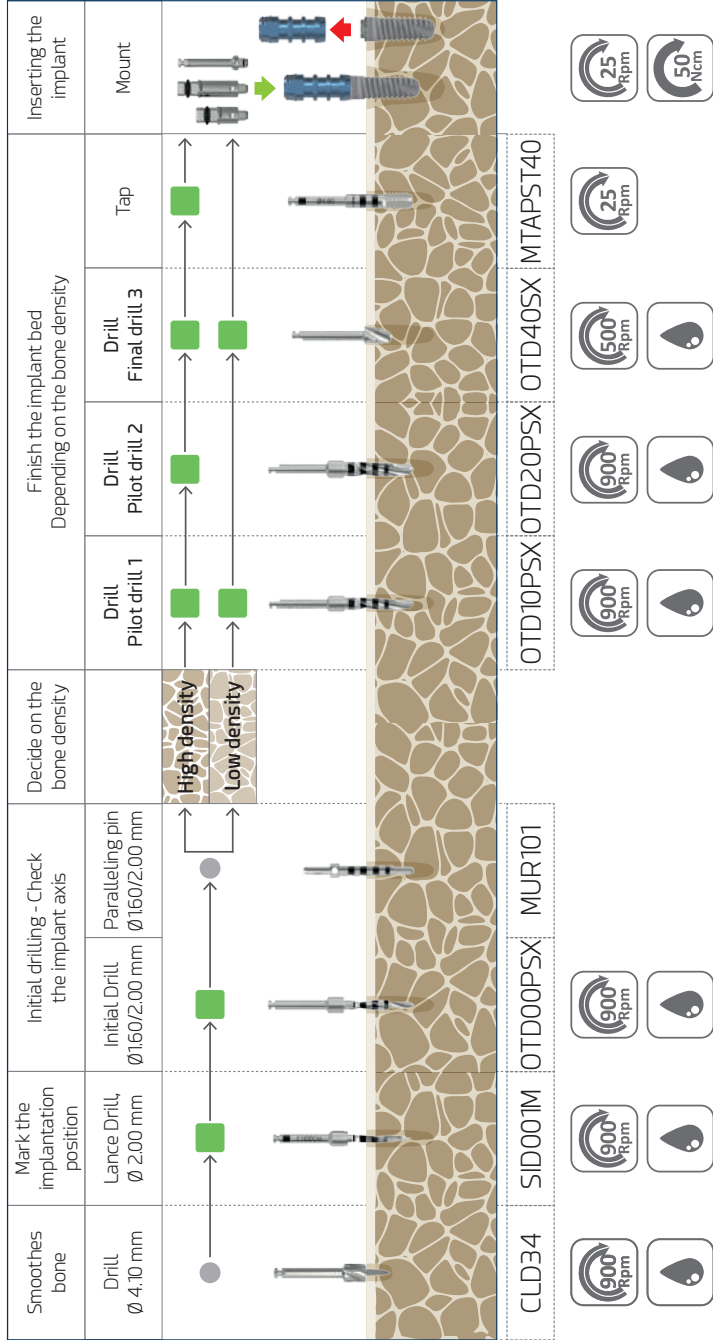

Key

- Optional
- Sequential

Simplified surgical protocol

ZM4 Ø4.30 (Example of implant bed preparation with ZM4 implant Ø4.30x11.5)

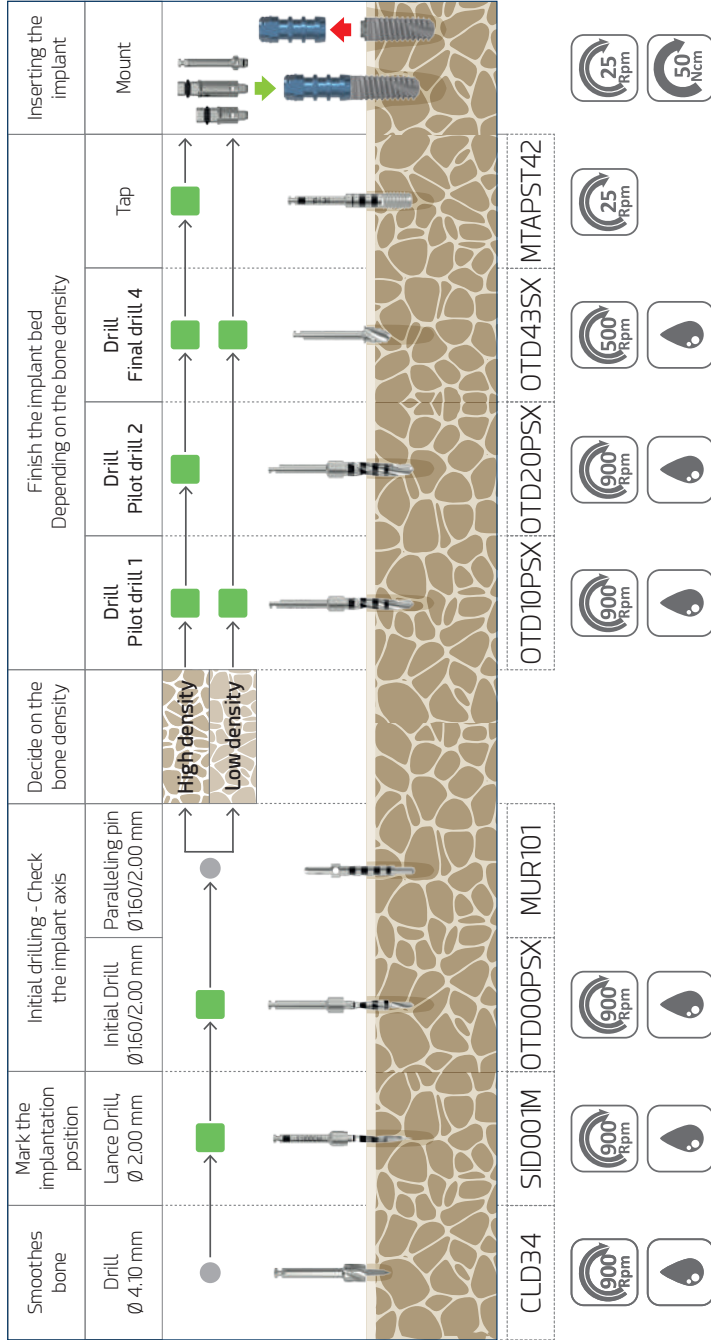

Key

- Optional
- Sequential

ZM4 Ø4.60

(Example of implant bed preparation with ZM4 implant Ø4.60x115)

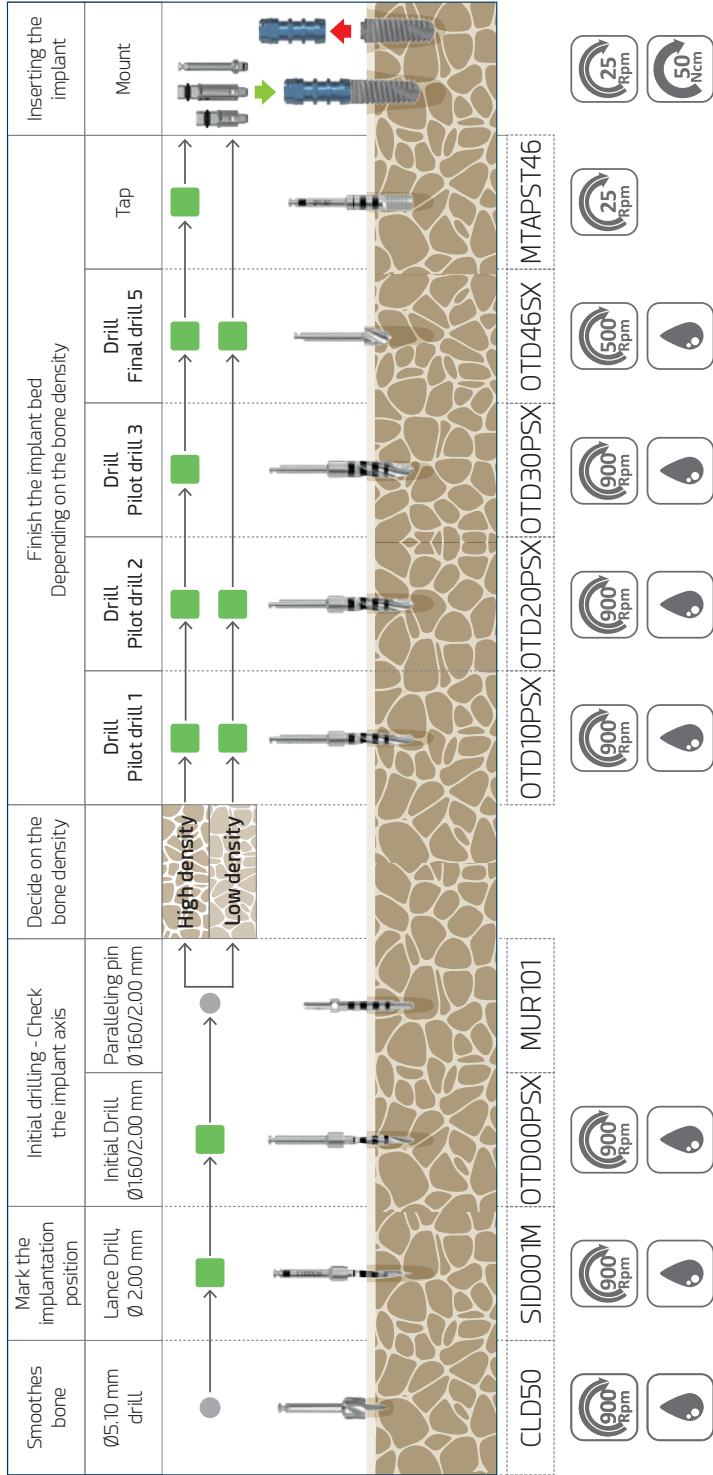

Key

-  Optional
-  Sequential

General recommendations

■ Points to consider during the procedure

1

Surgical drills must be inserted into the contra-angle handpiece with the motor stopped, ensuring that they are seated and rotate properly before starting drilling. Treat drills with the utmost care; the slightest damage to the tips could compromise their effective operation.

2

Damaged instruments must be disposed of according to local regulations.

3

Implantologists should keep one of the identification labels supplied with the product in the patient's records so that the product can be traced correctly.

4

Each instrument must only be used for the specific use recommended by the manufacturer.

Always consult the surgical and prosthetic protocols published in this catalogue, as well as the other documents available in the "Reference literature" section of our website www.ziacom.com/biblioteca which explain the procedures, protocols and instructions for use before using the Ziacom® ZM4 system.



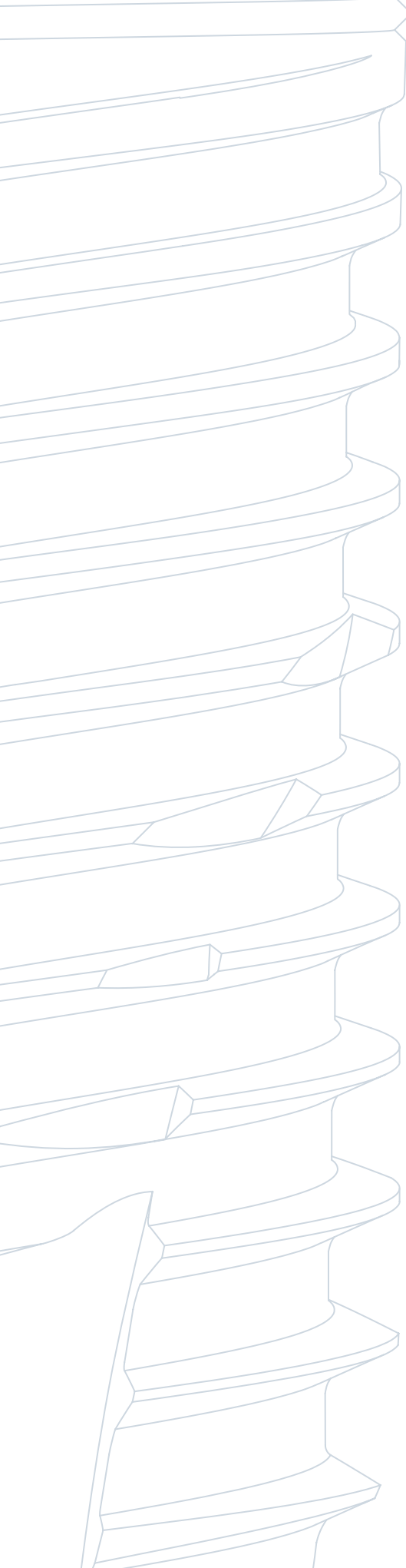

ZM4

Cleaning, disinfection and sterilisation



Cleaning, disinfection and sterilisation

The protocols described in this section must only be carried out by personnel qualified to clean, disinfect and sterilise the dental materials specified herein.

Cleaning and disinfection instructions

Applicable for surgical and prosthetic instruments and boxes.

■ Disassembly

1. Disassemble* the instruments that need to be cleaned and disinfected, such as manual ratchets, drills or drill stops.
2. Remove all the different components from the surgical or prosthetic kit box for correct cleaning.

■ Cleaning and disinfection

For disinfection of instruments and surgical kit boxes:

1. Submerge the instruments in a detergent/disinfectant solution** suitable for dental instruments to help eliminate any adhered biological residues. If an ultrasound bath is available***, confirm that the detergent/disinfectant solution is indicated for use with this type of equipment.
2. Manually remove any biological residues with a non-metallic brush and pH-neutral detergent.
3. Rinse with copious water.
4. When cleaning surgical and prosthetic kit boxes, always use a pH-neutral detergent and non-abrasive tools to avoid damaging the surface of the boxes.
5. Dry the materials with disposable, lint-free, cellulose cloths or compressed air.

For disinfection of plastic caps and the protective disk:

1. Submerge for 10 minutes in a neat benzalkonium chloride solution.
2. Rinse with distilled water.
3. Dry the caps and disk prior to use.

■ Inspection

1. Check that the instruments are perfectly clean; if not, repeat the cleaning and disinfection steps.
2. Discard any instruments with imperfections and replace them before the next surgery.
3. Check that the instruments and surgical and prosthetic kit boxes are perfectly dry before reassembling the parts and proceeding with sterilisation.

* See the assembly and disassembly manuals at www.ziacom.com/biblioteca

** Follow the instructions from the disinfectant's manufacturer to determine the correct concentrations and times.

*** Follow the instructions from the ultrasound bath's manufacturer to determine the correct temperature, concentration and times.

Sterilisation instructions for steam autoclaves

Applicable to orthodontic implants, abutments, kit, surgical and prosthetic boxes, pins, fixing screws and mesh membranes.

1. Place the material in individual sterilisation pouches and seal the pouches. For joint sterilisation, place the instruments in their surgical kit box, place the box in a sterilisation pouch and seal the pouch.
2. Place the pouches to be sterilised in the autoclave.
3. Sterilise in a steam autoclave at 134°C/273°F (max. 137°C/276°F) for 4 min (minimum) at 2 atm. Dynamometric torque wrenches must be sterilised in 3 vacuum cycles at 132°C/270°F for at least ≥ 4 minutes and vacuum dried for at least 20 minutes.

For the United States only: The validated and recommended sterilisation cycle for the US must be performed in a steam autoclave at 132°C/270°F for at least 15 minutes with a drying time of at least 15–30 minutes.

IMPORTANT

Make sure the drying stage is allowed to run to completion, otherwise the products may be damp.

Check the sterilisation equipment if the materials or sterilisation pouches are damp at the end of the sterilisation cycle.

Perform the necessary maintenance actions on the autoclave according to the established periodicity and following the manufacturer's instructions.



Storage of Ziacom® products

- Store the products in their original packaging in a clean, dry place until they are to be used.
- After sterilisation, keep the products in the sealed sterilisation pouches in a clean, dry location.
- Never exceed the use by date indicated by the manufacturer of the sterilisation pouches.
- Always follow the instructions of the manufacturer of the sterilisation pouches.

General recommendations

- Never use damaged or dirty material; never reuse single-use products. The user is responsible for following the instructions described in this document correctly.
- Pay attention to piercing or sharp elements. Gloves should be worn when cleaning the materials to avoid accidents during handling.
- Follow the safety instructions indicated by the manufacturer of the disinfectant.
- The product's sterility cannot be guaranteed if the sterilisation pouch is open, damaged or damp.
- Respect all stages of the sterilisation process. If the materials or sterilisation pouches contain traces of water or moisture, check the autoclave and repeat the sterilisation.
- Orthodontic abutments and implants are supplied UNSTERILISED and must always be sterilised before use.
- Instruments and surgical and prosthetic kit boxes are supplied UNSTERILISED and must always be sterilised before use and cleaned and disinfected after use.
- Sterilisation, cleaning and disinfection processes gradually deteriorate the instruments. Inspect the instruments thoroughly to detect any signs of deterioration.
- Avoid contact between products made from different materials (steel, titanium, etc.) during the cleaning, disinfection and sterilisation processes.
- Ziacom Medical SL recommends these instructions are implemented for the correct maintenance and safety of their products; accordingly, the company refuses any liability for any damage to the products that could arise if the user applies alternative cleaning, disinfection and sterilisation procedures.

See the latest version of the cleaning, disinfection and sterilisation instructions at www.ziacom.com/biblioteca



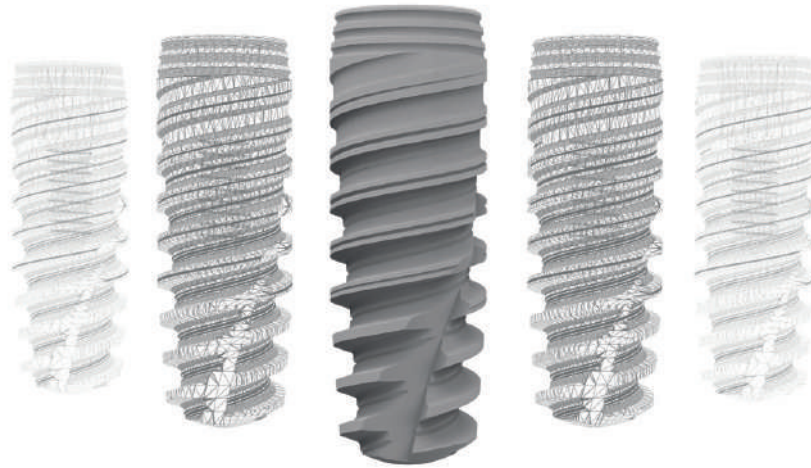

See the updated general conditions of sale at www.ziacom.com.

Check the availability of each product in your country.

All rights reserved. No part of this document may be reproduced or stored in any medium or reproduction system, nor transmitted in any way or under any concept, electronically, mechanically, in photocopies, recording or any other mean not considered here without the permission of holder of the copyright, editing and printing. Ziacom® is a registered trademark of Ziacom Medical SL.

See the latest version of the catalogues at www.ziacom.com.



EN | ENGLISH

